

PSY-201

Polarization Synthesizer/Analyzer

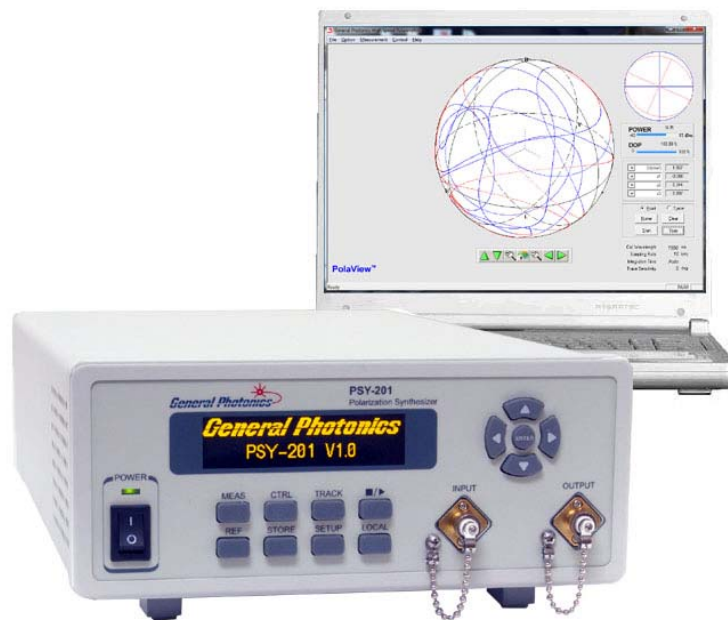

User Guide

Version: 1.1
Date: September 9, 2015

General Photonics Corporation is located in Chino California.

For more information visit the company's website at:

www.generalphotonics.com

or call 909-590-5473

SAFETY CONSIDERATIONS

The following safety precautions must be observed during operation of this product. Failure to comply with these precautions or with specific warnings elsewhere in this manual violates safety standards of design, manufacture, and intended use of the product. General Photonics assumes no liability for customers' failure to comply with these requirements.

Before operation, the user should inspect the product and review the manual carefully.

Properly ground the chassis and work space using the chassis ground terminal.

Use only in a safe work environment in terms of temperature, humidity, electrical power and risk of fire or shock. The product is designed for indoor use. Avoid exposure to liquids or water condensation. Provide adequate ventilation for cooling.

Operate the product on a stable surface. Avoid excess vibration.

Standard laser safety procedures should be followed during operation.

Never look into the light source fiber connector when the light source is turned on. THE OUTPUT LIGHT FROM A HIGH POWER LASER IS HARMFUL TO HUMAN EYES. Follow industry standard procedures when operating a high power laser source.

Section 1.0 Overview 7

1.1 Principle of Operation..... 7

Section 2.0 Features 11

2.1 Front Panel and Optical Inputs 11

Fiber Connectors12

Ferrule Cleaning Procedure12

2.2 Rear Panel: Electrical and Remote Control Interfaces 13

Section 3.0 Operation Instructions 15

3.1 Unpacking 15

3.2 Front Panel Operation 15

3.3 Functions..... 19

Polarization Measurement.....19

Polarization Control20

Track and ■/► Buttons.....31

Reference.....32

Store33

Setup.....34

Local44

3.4 Troubleshooting 45

Front Panel.....45

Remote Control45

Section 4.0 Specifications 47

Optical.....47

Electrical/Communication47

Physical and Environmental48

System48

SOP Measurement/Control Functions (front panel)48

Appendices 50

PSY-201 User Guide

Appendix 1.0 Remote Control Commands	50
<u>Command Lists</u>	<u>50</u>
Appendix 2.0 RS-232 connection and setup	68
Appendix 3.0 USB connection and setup	69
Appendix 4.0 Ethernet setup.....	70
Appendix 5.0 GPIB setup and control.....	72
<u>Setting the GPIB Address</u>	<u>72</u>
<u>GPIB control</u>	<u>72</u>
Appendix 6.0 PolaView data display/analysis program.....	73
<u>Instrument Compatibility</u>	<u>75</u>
<u>System Requirements</u>	<u>75</u>
<u>Software Installation</u>	<u>76</u>
<u>Software Removal</u>	<u>76</u>
<u>Setup</u>	<u>76</u>
<u>Poincaré Sphere Display</u>	<u>76</u>
<u>Oscilloscope Display</u>	<u>78</u>
<u>Option Menu</u>	<u>79</u>
<u>Measurement Menu</u>	<u>92</u>
<u>Control Menu</u>	<u>101</u>

Section 1.0 Overview

The PSY-201 Polarization Synthesizer/Analyzer combines General Photonics' PolaDetect™ (POD-201) high speed in-line polarimeter and PolaRite™ III polarization controller with reset-free, proprietary polarization control algorithms to achieve a wide range of polarization control functionalities: the ability to generate and maintain any desired state of polarization (SOP), regardless of the input SOP; real-time SOP and DOP monitoring; generating special SOP points, sequences, and traces; polarization scrambling and modulation. It is packaged in a 2U-height, half-rack size enclosure, as shown in Figure 1. The all-fiber construction polarization controller provides very wide operation bandwidth with extremely low insertion loss, polarization dependent loss, and activation loss. Applications include real-time polarization measurement and control, transceiver polarization testing, passive/active component characterization, interferometry, optical remote sensing, RF photonics, and other polarization sensitive applications.

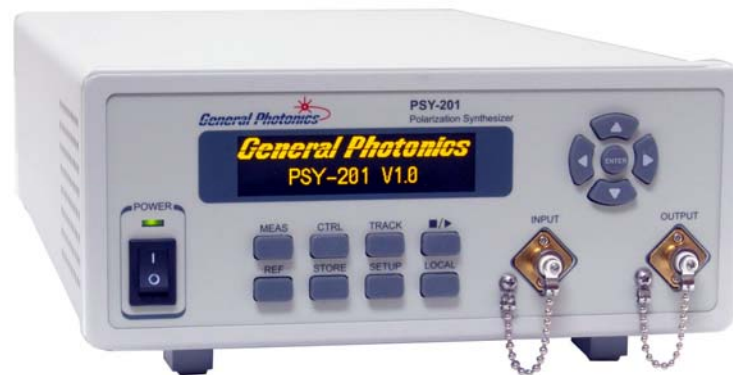

Figure 1 PSY-201 polarization synthesizer/analyzer

1.1 Principle of Operation

A polarization controller can be constructed from either a series of rotatable fixed-retardation plates or a series of variable retardation plates of fixed orientation. An example of the latter scheme, using four variable retardation wave plates, is shown below, in Figure 2a. Figure 2b shows a fiber-based version of this design, which consists of four piezoelectric actuator-driven fiber squeezers oriented 45° from each other. Each fiber squeezer is driven by an applied voltage signal. Squeezing the optical fiber produces a linear birefringence in the fiber, and thus, alters the state of polarization of a light signal passing through it.

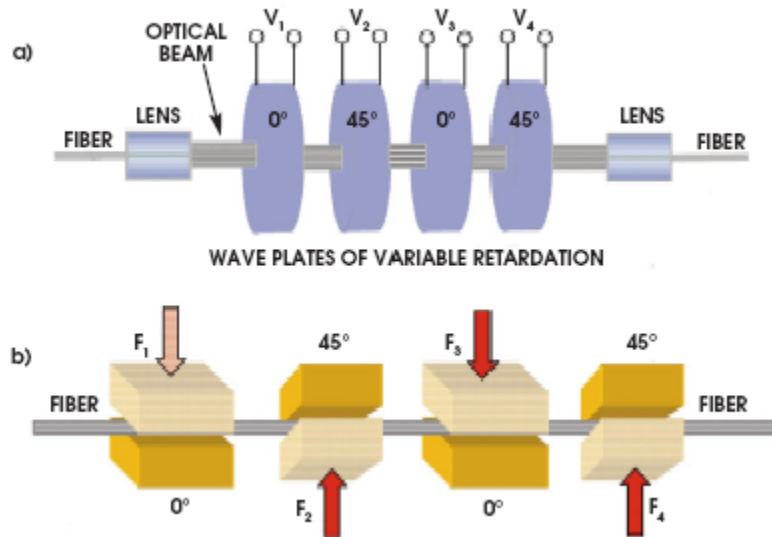

Figure 2 a) Free space construction of variable retardation plate polarization controller
 b) Fiber squeezer construction of variable retardation plate polarization controller

Any polarization state of monochromatic light can be represented as a point on the Poincaré Sphere, as shown in Figure 3. In principle, increasing the voltage (increasing the squeezing pressure) on one fiber squeezer (X1 or X3) effectively causes the polarization state to rotate clockwise about the OQ axis while decreasing the voltage causes the point to rotate counter-clockwise. Likewise, increasing the voltage to a fiber squeezer (X2 or X4) oriented 45° from the first one should cause the polarization state to rotate clockwise about an axis (OH axis) orthogonal to the first one, while decreasing the voltage should rotate the polarization counterclockwise. In practice, because of the presence of other birefringences, two parallel fiber squeezers do not always rotate the polarization about the same axis. However, it has been proven to be possible to generate any polarization state from an arbitrary input polarization state using this system.

Strictly speaking, a 3-axis fiber squeezer polarization controller is sufficient to generate any state on the Poincaré sphere. However, adding more fiber squeezers to the system provides more degrees of freedom, enabling reset-free operation, a highly desired feature for many dynamic applications. The PSY-201 uses a 6-axis version of the fiber squeezer based Polarite™ III polarization controller to achieve rapid, reset-free polarization control.

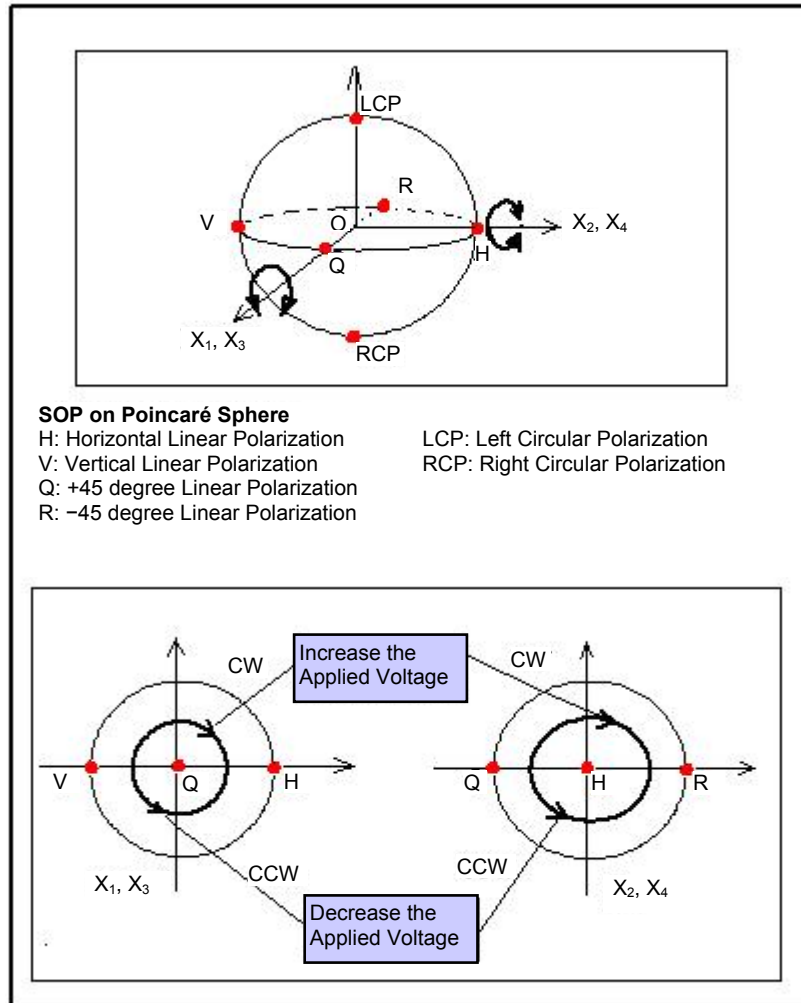

Figure 3 Poincaré Sphere SOP representation and illustration of effects of fiber squeezers

By using different modes of control of the drive voltages, the polarization controller can be made to perform various functions. In the SOP search modes, the instrument uses the internal polarimeter and feedback control circuit to automatically adjust the DC drive voltages to each of the 6 fiber squeezers to change the output polarization from any initial state to the desired final state.

Proprietary polarization control algorithms can compute drive voltage sequences to generate preset SOP patterns on the Poincaré sphere. These functions can be used to step periodically through a stored sequence of SOPs or to trace out a great circle of the sphere in either direction about one of 3 rotation axes.

In polarization scrambler mode, the PSY-201 scans the output polarization state evenly over the Poincaré sphere at a user specified rate, using a random pattern, a triangle wave - based algorithm, or a unique spiral-based Tornado pattern. This allows the output polarization state to

PSY-201 User Guide

change either in a series of random jumps at defined intervals, or in particular continuous patterns.

In addition to generating the Stokes parameters for the PSY-201's polarization control functions, the PSY-201's internal in-line polarimeter, in conjunction with the PolaView™ data analysis and display software, provides real-time graphic display of polarization state either on a Poincaré Sphere window for viewing SOP traces or on an oscilloscope window for monitoring polarization changes over time. This polarization analysis system allows the user to simultaneously control and monitor the PSY-201's output polarization. It can also be used to monitor the polarization state in the external system without interrupting data traffic.

Note: Unlike that of a free-space optics system, the coordinate system is not maintained during propagation through optical fiber. Therefore, although the relative positions of SOPs generated by the PSY-201 are maintained, their absolute positions relative to a fixed external coordinate system may change during propagation.

Note: The Stokes parameters provided by the POD-201 and PSY-201 are normalized to the surface of the Poincaré sphere: They satisfy the normalization condition $s_1^2 + s_2^2 + s_3^2 = 1$. This means that they are already normalized for both power and DOP.

Section 2.0

Features

2.1 Front Panel and Optical Inputs

The front panel of the PSY-201 is shown in Figure 4.



Figure 4 PSY-201 front panel

Front panel features:

OLED display: Displays data and operation mode information.

Power: Power on/off switch.

Input: Adapter for optical fiber input.

Output: Adapter for optical fiber output.

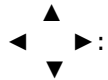

Arrow keys: used to set measurement/control parameters.

Enter: Select/Execute button.

MEAS: Display measured values.

CTRL: Access polarization control function menu.

TRACK: Enables/disables active stabilization of current generated or measured SOP. Stops any SOP pattern generation function when enabled.

■/▶: Enables/disables any active polarization control function. For continuous pattern generation (triangle or Tornado scrambling or modulation), this button acts as a pause/resume switch. While paused, the polarization controller remains in its most recent setting, and the pattern generation resumes from the same point.

REF: Set or display reference SOP values.

STORE: Store measured or user-configured data to memory for stored-state scan.

SETUP: Access system setup menu.

LOCAL: Restores local (front panel) control when system is under remote control.

Fiber Connectors

The PSY-201 has two fiber connectors on the front panel for the optical input and output. The front panel adapters are universal connector interfaces (UCI), which feature a male-type adapter top piece that can be removed for direct access to the ferrule end for routine cleaning and maintenance without removing the entire adapter from the panel. This feature helps avoid high insertion loss, high return loss and measurement instability caused by dirty or contaminated connectors. In addition, the PSY-201's universal interchangeable adapter allows the user to switch to ST, SC, or FC connectors without opening the instrument panel. Although the PSY-201 is shipped with a customer specified fiber adapter, other interchangeable inserts are available. For additional information on different input fiber adapter inserts, please contact General Photonics.

External fiber connectors should be cleaned using industry standard cleaning methods before connection to the PSY-201. If this procedure is followed before each connection, the instrument's internal connector ferrules should not need regular cleaning. However, high insertion loss or measurement instability that does not improve after cleaning the external connectors may indicate that the instrument's internal connector ferrules require cleaning.

Ferrule Cleaning Procedure

Each connector ferrule is contained in a universal connector interface consisting of a front piece that connects to the external fiber connector and a base piece that is mounted on the front panel of the instrument, as shown in Figure 5. To clean a connector ferrule, first, make sure no external connector is connected to the universal connector interface. Then, using a Phillips screwdriver, remove the two small screws connecting the front and back parts of the adapter, and carefully pull the front flange straight out. (Note: never remove the adapter base from the front panel). The ferrule end should now be exposed. Clean the ferrule using standard cleaning procedures (compressed air or a fresh lint-free tissue and alcohol or other connector-cleaning solvent), taking care to avoid scratching the ferrule surface. Finally, replace the front flange (position it so that the key notch faces up, and the small alignment pin lines up with the hole in the base piece, before pushing it in) and the screws. For frequent measurements, we recommend that the user prepare a patch cord fiber to avoid wear on the internal connector.

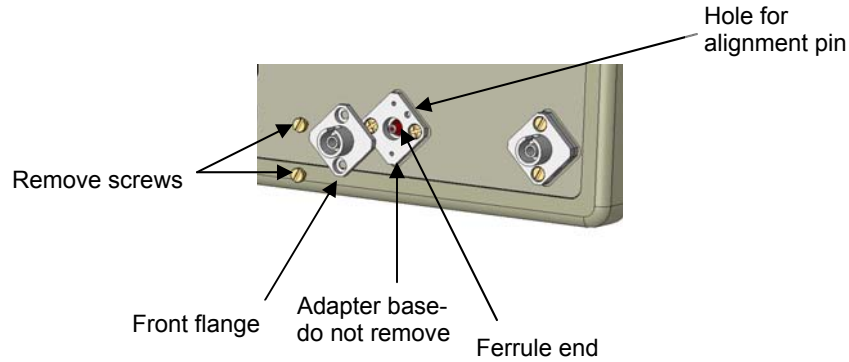

Figure 5 Diagram of universal connector interface

2.2 Rear Panel: Electrical and Remote Control Interfaces

The AC power plug, fuse, trigger and communication interface connectors are mounted on the rear panel, as shown in Figure 6.

The PSY-201 includes RS-232, USB, Ethernet, and GPIB interfaces for remote control and communication. Control commands, USB driver installation instructions, and instructions for running control programs are located in the appendices.

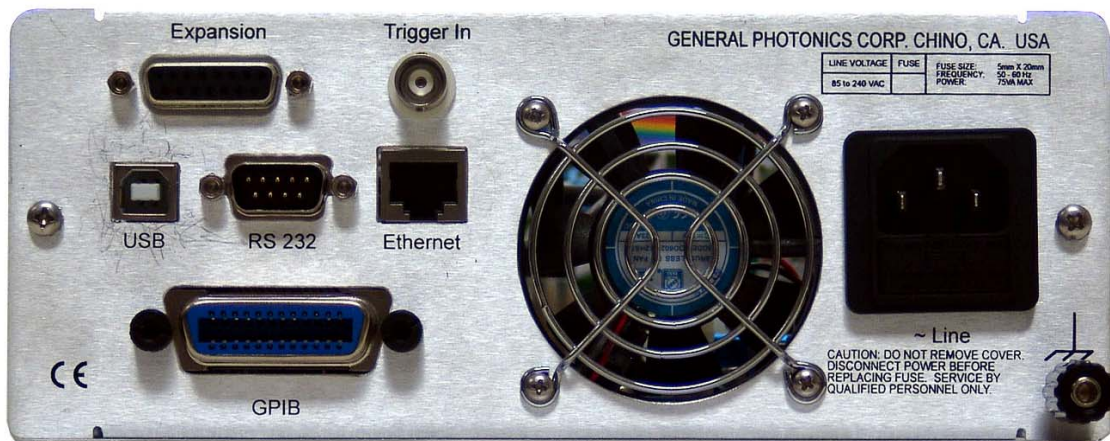

Figure 6 Rear panel

Rear Panel Features:

Expansion: DB15 connector- analog outputs, dREF, tracking, and scrambling triggers	Line: External AC input connector 100-240VAC
Trigger In: BNC for SOP measurement trigger	Cooling fan air intake
USB 2.0 interface port (PolaView only)	Ethernet interface port
RS-232 serial interface port	⏏ : Chassis ground
GPIB interface port	

PSY-201 User Guide

Expansion port pin definition:

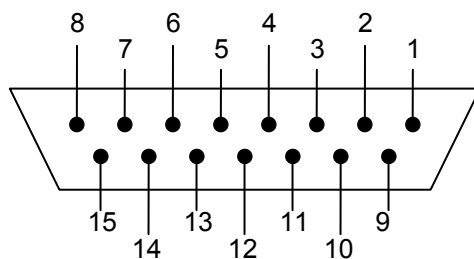

Figure 7 DB15 female connector on rear panel of PSY-201

Pin #	Function	Note
1,2,3,4,5,6,7	Ground	
8	Tracking trigger out GPIO-4	Tracking status indicator. If dSOP between target and current SOP is Within threshold: TTL low Beyond threshold: TTL high
9	Analog Output 1 (AO1)	Analog outputs can be configured to output S1, S2, S3, DOP, Power, or dREF. 0-5V DAC output.
10	AO2	
11	AO3	
12	AO4	
13	SOP scrambling trigger input GPIO-0	One random SOP generated per rising TTL pulse received
14	SOP scrambling trigger out GPIO-2	In discrete scrambling mode, one rising pulse output per SOP generated.
15	dREF trigger out GPIO-3	Within threshold: TTL low Beyond threshold: TTL high

Fuse location:

Figure 8 shows the location of the fuse compartment under the power cord plug. There are two fuses in the compartment- the one in use and a spare. The fuse further inside the compartment is active. The one closer to the compartment opening is the spare.

Replace the fuse with one with the exact rating of the original.



Figure 8 Fuse compartment

Section 3.0 Operation Instructions

3.1 Unpacking

Inspect PSY-201 for any physical damage due to shipping and transportation. Contact carrier if any damage is found. Check the packing list to see if any parts or accessories are missing.

Packing List

Item #	Description
1	PSY-201
2	Power cord
3	USB cable
4	User guide
6	Software cd

3.2 Front Panel Operation

1. Connect power cord and plug it into wall receptacle. Make sure the ground pin of the power cord is connected to earth ground.
2. Connect input and output fibers to the PSY-201. Make sure that the connector types match those of the instrument. It is important to clean the fiber connectors using industry standard procedures before connecting them. If using a high power laser source, turn off optical power source before connector cleaning.
3. Turn on light source. Make sure light source power is within range (-35 to $+10$ dBm).
4. Turn on the PSY-201. It will run through an initialization sequence, during which the OLED screen will display the instrument identification. Once the initialization is complete, it will display the main measurement screen.

GENERAL PHOTONICS
PSY-201 VER.1.3



0.132, -0.548, 0.826 ^{POL}
DOP: 100.0 % P: 1.00 dBm _L

← Polarimeter

← Local control

PSY-201 User Guide

The PSY-201 has two main functions: polarization measurement and polarization control. Other support functions such as SOP reference, storage and system setup will also be discussed in this section. The operation modes will be described in the order of the corresponding front panel buttons, using the PolaView™ software display where necessary to illustrate their functions on a Poincaré Sphere representation. The function layout is shown in Figure 9, which will be referenced throughout this section.

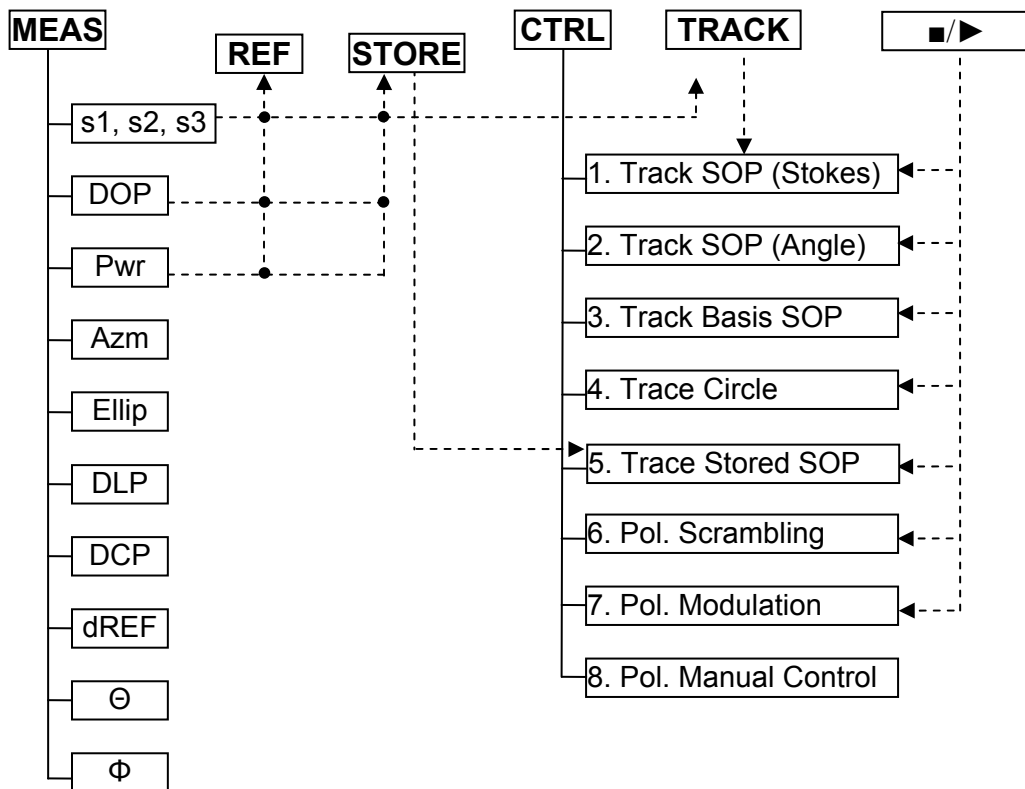

Figure 9 Measurement/control function menu tree

PSY-201 User Guide

The system setup menu is shown in Figure 10.

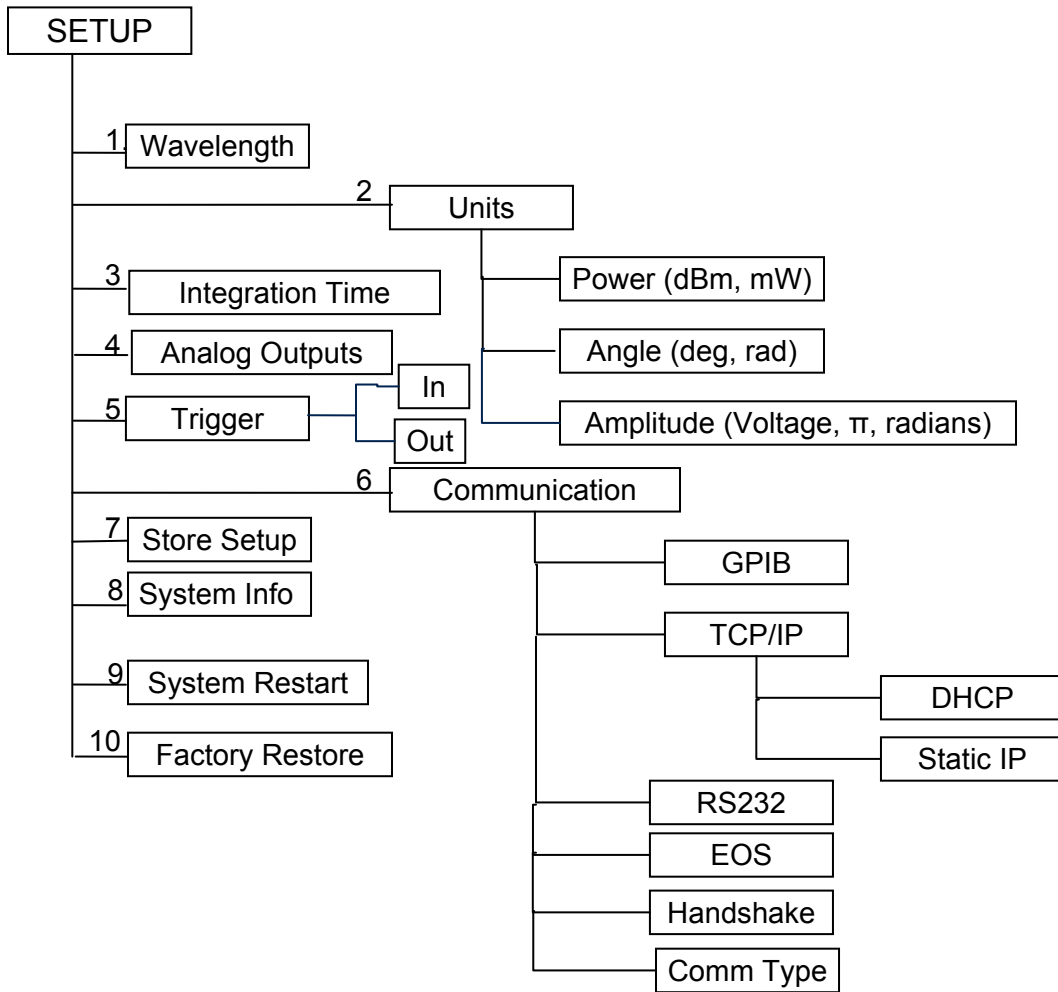

Figure 10 System menu tree

3.3 Functions

The polarization measurement and control functions and setup options are described in more detail in this section.

Polarization Measurement

When the PSY-201 is first powered on, after initialization, its default mode is polarization measurement.



This measurement display can also be accessed at any time by pressing the MEAS button. Normalized Stokes parameters s_1 , s_2 , and s_3 are displayed in the first row. The second row shows two user-configurable parameters. For each of these positions, the user can choose to display DOP, Power, Azimuth, Ellipticity, DLP, DCP, dREF, Θ , and Φ . The display parameters can be selected by using the arrow keys.

While in the measurement display, the MEAS button can be used to pause/resume display updating. A "||" icon above the "L" indicates that measurement is paused.

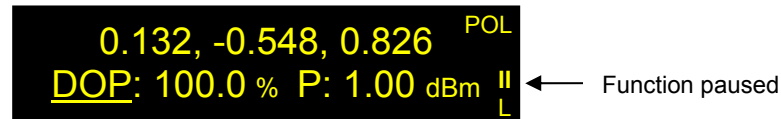

In addition to the front panel display, measured data can be displayed on a Poincaré sphere or virtual oscilloscope plot using the PolaView™ software. This is useful for tracking SOP evolution patterns or fast changes in polarization.

If the input optical power is out of range, the parameter display positions will be blank and a "PL" or "PH" indicator will appear on the right center of the screen.

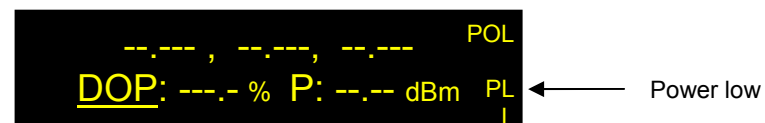

Polarization Control

The CTRL button brings up the polarization control menu, with the menu tree shown in Figure 9. The function definition of each menu item is described in the following sections. Use the arrow keys to move between options and the ENTER key to select a function.

Track SOP (Stokes)

This function allows the user to set and maintain a target SOP by entering the Stokes Parameter representation of the target SOP. Use the arrow keys to input the desired values (◀▶ to move the cursor and ▲▼ to change the value of the selected digit). Press ENTER to move to the next parameter setup position. Once all 3 values are entered, use the [Track] softkey to automatically normalize the Stokes parameters and tune the output SOP to the desired setting. On the OLED, a target icon appears in the top right of the screen.

Once the SOP is set, the ■/▶ button can be used to enable/disable active stabilization of the output SOP. The target icon indicates the enable/disable status of the function. Target = enabled; no target = disabled.

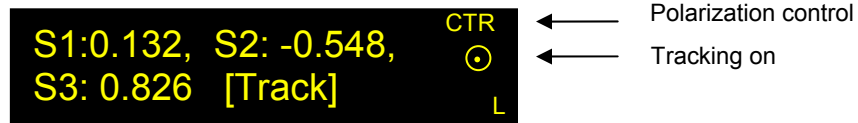

The figure below demonstrates on the Poincaré sphere that a polarization scrambled input can be stabilized to a specific SOP by the PSY-201.

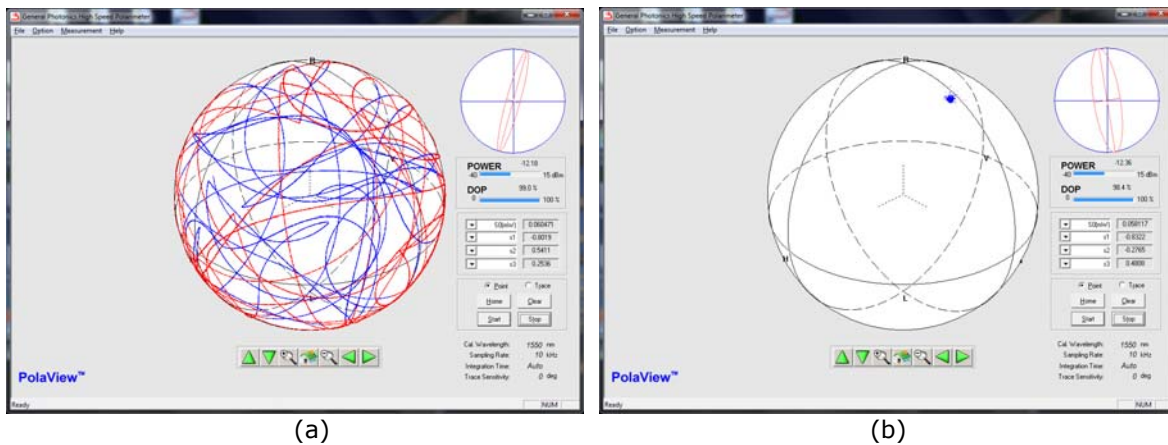

Figure 11 (a) Input polarization pattern: triangle wave scramble at 1 Hz, taken over 20 sec. (b) Output polarization stabilized by PSY-201 against the same polarization-scrambled input.

Track SOP (Angle)

This function allows the user to set and maintain a target SOP by specifying its spherical coordinates on the Poincaré sphere, as shown in Figure 12, rather than by specifying Stokes parameters. This representation is simpler in some respects, as it does not require vector normalization and can be easier to visualize.

Select the desired output polarization state by specifying the angles Θ and Φ on the spherical coordinate system of the Poincaré sphere.

Ranges:

Θ 0° to 360°

Φ 0° to 180°

Use the  button to enable/disable this function. The target icon indicates the enable/disable status of the function. Target = enabled; no target = disabled.

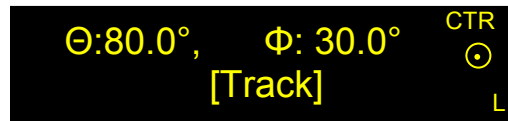

Relationship of spherical coordinates to S-parameters:

$$\theta = \tan^{-1}\left(\frac{S_2}{S_1}\right), \quad 0 \leq \theta < 360^\circ$$

$$\phi = \cos^{-1}\left(\frac{S_3}{\text{norm}(\vec{S})}\right), \quad 0 \leq \phi \leq 180^\circ$$

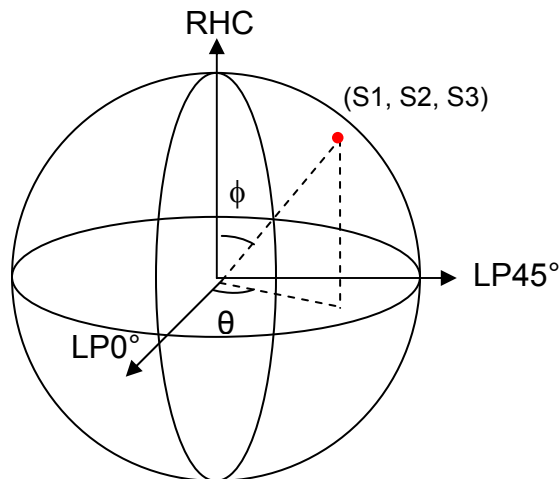

Figure 12 SOP shown in spherical coordinate representation

Track Basis SOP

Track Basis SOP is a shortcut for tracking to one of the basis SOPs spanning the Stokes space: LP0° (1,0,0), LP45° (0,1,0), LP90° (-1,0,0), LP135° (0,-1,0), RHC (0,0,1), and LHC (0,0,-1).

Use the arrow keys to select the desired state and the ENTER button to generate it.

Use the **■/▶** button to enable/disable this function. The target icon indicates the enable/disable status of the function. Target = enabled; no target = disabled.

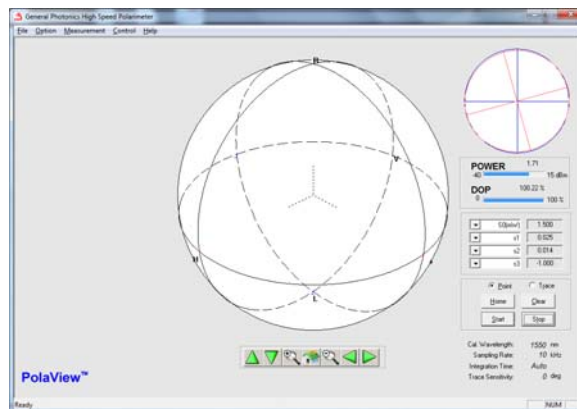

Figure 13 Poincaré sphere representation showing the 6 basis states.

Tracking Threshold and Tracking Status Output Trigger

In addition to setting a target SOP to be generated, the user can control how closely the PSY-201 maintains the target SOP. For the PSY-201's active tracking functions, the dSOP tracking threshold defines the maximum allowed angle deviation from the target SOP before active tracking begins. The threshold can be set via the :CONFigure:TRACK:THREshold remote control command only. Figure 14 demonstrates the function of the tracking threshold. The blue area on the Poincaré sphere includes the SOPs that are within threshold of the target SOP. As long as the output SOP remains within this area, the PSY-201 does not apply any corrections. Once the output SOP goes outside the blue area, the PSY-201 will act to bring it back within the blue area. Therefore, as long as the tracking function is active, the PSY-201 will maintain the output SOP within the blue area. The user controls the size of the blue area by setting the tracking threshold.

For relatively stable signals, setting the threshold just above the noise level can decrease the effect of noise on the output signal.

The tracking status output trigger indicates whether the output SOP is within threshold or not.

PSY-201 User Guide

dSOP Threshold Range: 0 to 180° from target SOP on Poincaré sphere Default: 0°

Tracking status trigger:

TTL level low = within threshold (SOP inside blue area)

TTL level high = out of threshold (SOP outside blue area)

Electrical connection: Pin 8 on DB15 expansion connector

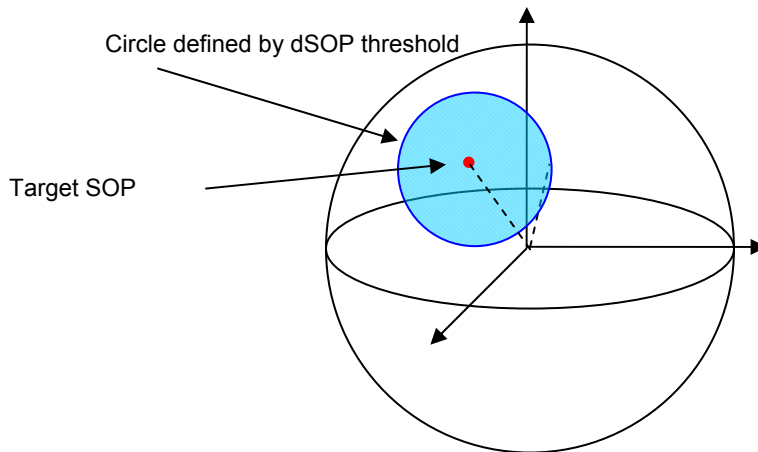

Figure 14 Tracking status threshold

Trace Circle

Trace circle is a preprogrammed function that traces a great circle around the sphere, centered on one of the basis SOPs as the principal state of polarization (PSP). LP90°, LP135°, and LHC rotate in opposite directions from LP0°, LP45°, and RHC, respectively. The trace direction follows the right hand rule (counterclockwise rotation when looking into the specified SOP). The step size and dwell time at each step can be configured before starting. While the tracing is in process, the user can pause or exit the function using softkey options. While the function is paused, the user can continue, restart, or exit the function using softkey options. Use the arrow buttons to cycle through softkey options.

While the function is paused, setup parameters cannot be changed. Exit the function to change setup parameters such as step size or dwell time.

The function can also be enabled/disabled using the **■/▶** button. The circle trace icon indicates the enable/disable status of the function. Icon = enabled; no icon = disabled.

PSP: LP0 Step: 001.0° CTR ① ← Circle trace icon
 Dwell: 00100ms [Run] L

PSP options: LP0, LP90, LP45, LP135, RHC, LHC
 Step range: 0.1 to 180°
 Dwell time: 10 to 65535 ms

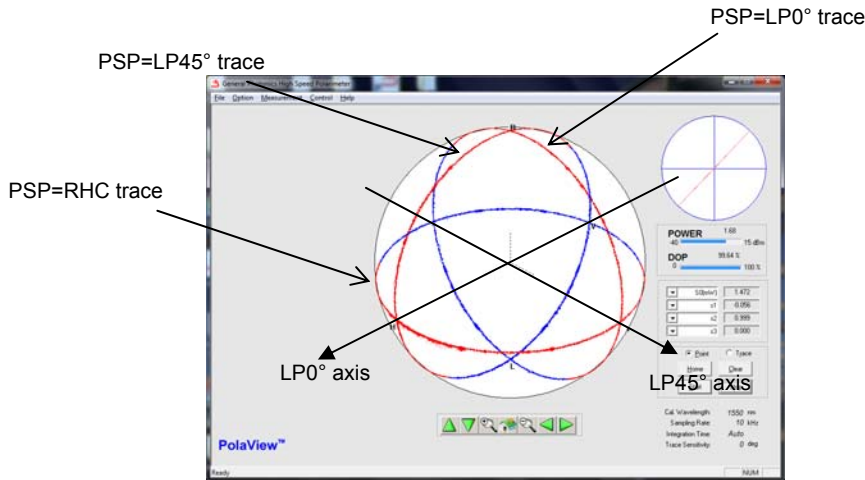

Figure 15 Poincaré sphere representation of the circles traced around 3 PSP axes: LP0, LP45, and RHC

Trace Stored SOP

This function allows the user to step through a sequence of stored SOPs. The start and end ID numbers, and the dwell time at each stored SOP can be configured. Once the sequence has begun, the user can pause or exit the function using softkey options. The counter displays the storage ID corresponding to the current SOP. While the function is paused, the user can continue, restart, or exit the function using softkey options. Use the arrow buttons to cycle through softkey options.

The function can also be enabled/disabled using the $\blacksquare/\blacktriangleright$ button. The sequence will repeat as long as the function is enabled.

ID: 01 to 99 CTR 10 ← Counter
 Dwell: 00100ms [Run] L

ID range: 0 to 99
 Dwell time range 10 to 65535 ms

PSY-201 User Guide

The SOP sequence to be used for this function can be input using the STORE function, which will be described later. Stored SOPs can be measured data or can be manually input by the user.

Pol. Scrambling

The PSY-201 can function as a variable speed polarization scrambler. There are four scrambling modes: Triangle, Discrete, Tornado, and Triggered.

Scrambling control sequence:

1. Set type.
2. Set rate.
3. For Tornado mode only, select axis rotation option.
4. Press **■/▶** button to begin scrambling. Once scrambling has begun, the **■/▶** button acts as a pause/resume button. The presence or absence of the scrambling function icon (a triangle wave for triangle scrambling, a pair of dice for discrete scrambling, and a horizontal or vertical whirlwind icon for tornado scrambling) indicates the enable/disable status of the function. The icon disappears when the function is paused or disabled.

Triangle Scrambling

Triangle scrambling changes the output polarization state based on a combination of triangle waves of user specified frequency. During triangle scrambling, the polarization changes continuously at a rate determined by the scrambling rate setting, in a pattern that will cover the entire Poincaré sphere. This function can be used for such applications as PDL measurement, in which the maximum and minimum light output power as a function of input polarization state is measured: for maximum accuracy, all polarization states need to be covered, but each power reading should be taken at a distinct polarization state. Since the photodetector in such a measurement often cannot follow a fast polarization scrambler, a function in which the polarization changes continuously allows the photodetector to average over states that are close to each other for each reading. Figure 16 shows a sample SOP trace for triangle scrambling at a rate of $1 \times 2\pi/s$ after 1 minute.



Rate: 0 to $2000 \times 2\pi/s$ for triangle scrambling

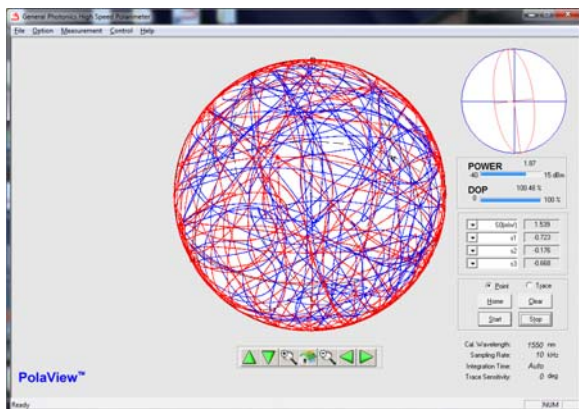
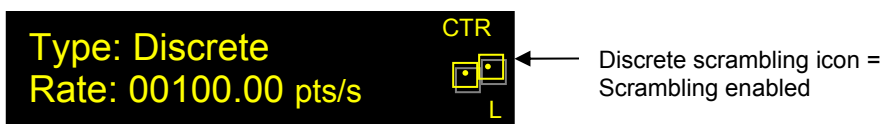

Figure 16 Triangle wave scramble trace, $1 \times 2\pi/s$ after 1 minute.

Discrete Scrambling

Discrete scrambling sends random combinations of drive voltages to the fiber squeezers, causing the polarization to make step changes to different random states at time intervals determined by the selected frequency. This pattern also generates even coverage of the Poincaré sphere, and can be used at high frequencies for applications requiring unpolarized light. Figure 17 shows a sample SOP variation pattern. When discrete scrambling is activated, an icon resembling a pair of dice appears on the right hand side of the screen.



Rate: 0 to 20,000 points/s for discrete scrambling

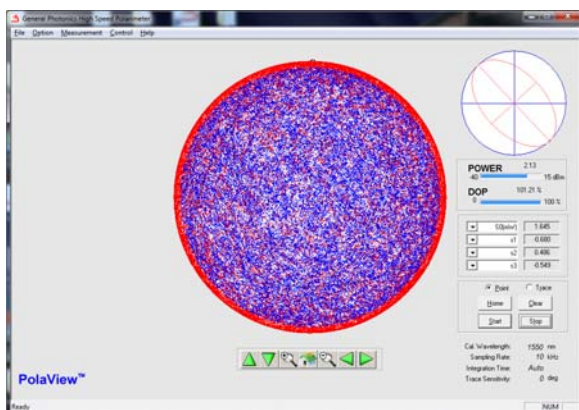

Figure 17 Discrete scramble, 1000 points/s after 30 seconds.

Discrete Scrambling Output Trigger

When in discrete scrambling mode, the PSY-201 sends a rising TTL pulse synchronized with each output SOP change to pin 14 of the DB15 expansion port on the rear panel. This output trigger signal can be used to synchronize to an external device.

Tornado Scrambling

Tornado scrambling generates a continuous bidirectional spiral polarization trace with a quasi-uniform rate of SOP variation, which is useful in stress testing a device or an algorithm's polarization tracking capabilities. The user-set scrambling rate is the number of complete circles traced out on the sphere per second. While the number of revolutions per second is constant, the SOP variation rate in rad/s can vary depending on where on the sphere the circle is. The maximum value of ΔSOP occurs when the rotation is around the equator, in which case, $\Delta\text{SOP} = 2\pi$ (# rotations/s).

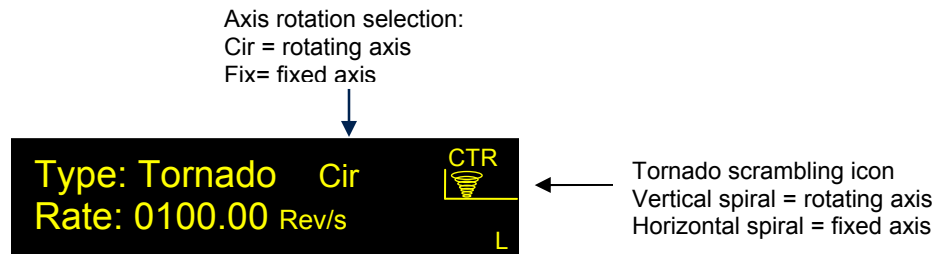

Rate: 0 to 2000 revolutions/s for Tornado scrambling

Spin axis rotation: Cir = axis rotation enabled
 Fix = axis rotation disabled

Tornado scrambling can be performed by tracing out the spiral with either a fixed or randomly rotating spin axis, as shown in Figure 18. Select the "Cir" or "Fix" axis rotation option to enable or disable, respectively, the rotation of the spin axis. The tornado scrambling icon in the top right of the control screen indicates the axis-rotation status. If the axis is rotating, the tornado icon is vertical. If the axis is fixed, the tornado icon is horizontal. The default state is axis rotation enabled. As with other scrambling modes, the icon disappears when scrambling is disabled.

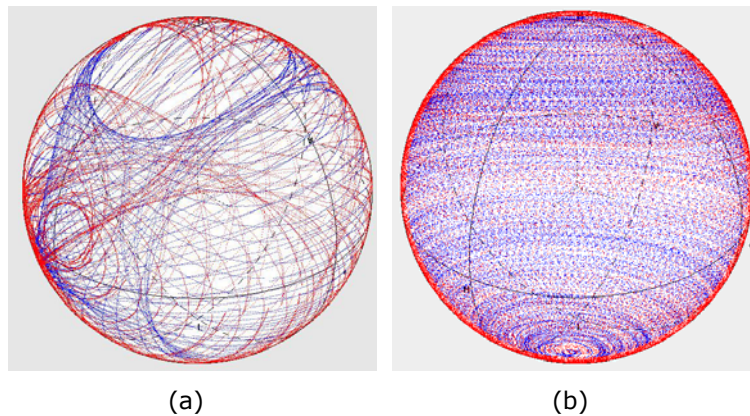

Figure 18 10 second SOP capture of tornado scrambling: (a) randomly rotating spin axis at 20 revolutions per second, (b) fixed rotating spin axis at 100 rev/s.

PSY-201 User Guide

Trigger In

The final "Pol. Scrambling" operation mode is triggered random state generation. This is the same function as discrete scrambling, except that the transition to the next random state occurs on receipt of a trigger pulse rather than at a predetermined rate. This function can be used to synchronize with other equipment. One such application is in a recirculating loop experiment. To use this function, select "Trigger In" as the scrambling option.



Connect external trigger (TTL signal) source to pin 13 on the DB15 expansion port connector on the rear panel of the PSY-201.

- Pulse type: rising (0-5V) TTL pulse
- Minimum pulse width: 100ns
- Threshold voltage for TTL high: 2V.
- Threshold voltage for TTL low: 0.7V.

Pol. Modulation

This function allows the user to customize SOP variation patterns by independently modulating each fiber squeezer (channel) with separate waveforms. The waveform type, modulation amplitude, frequency, and DC offset can be set for each channel.

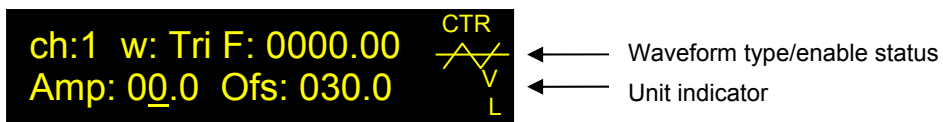

- Channel (ch): 1 to 4
- Waveform (w): sine, square, triangle
- Frequency (F): 0 to 1000 Hz
- Amplitude (Amp):

	Voltage	n	Radians
Amplitude Range	0.0 to 45.0	0.0 to 1.5	0.0 to 4.71

Offset (Ofs): depends on amplitude

The relationship between amplitude and offset is:

$$\text{Amp} \leq \text{Ofs}$$

$$\text{Ofs range: } A \text{ to } (2A_{\text{max}} - A)$$

Where A_{max} is the upper range limit listed in the amplitude table.

PSY-201 User Guide

The waveform graphic indicator appears when modulation is enabled, and indicates the waveform type for the selected channel. The unit indicator indicates the units for the parameter that is being set (e.g. Hz for frequency; V, n, or Rad for amplitude and offset).

After setting the modulation parameters for one or more channels, press the **■/▶** button to enable the modulation. For the modulation function, the **■/▶** button acts as a pause/resume button.

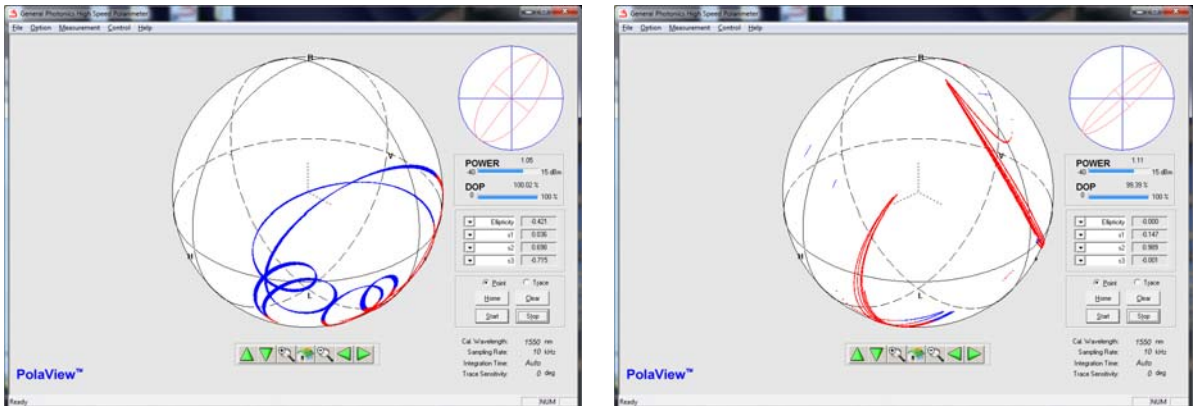

Figure 19 Sample modulation patterns.

Pol. Manual Control

This function allows the user to change the output polarization state through direct control of the control voltages applied to the four channels of the polarization controller. In all of the other control modes, the user selects a desired polarization state or series of states, and then the PSY-201 determines and applies the control voltages required to generate the requested state(s). This direct control mode allows for quick, almost continuous tuning of the polarization state, and is especially convenient when the output polarization state can be simultaneously monitored using the PolaView™ display software. As mentioned in the introduction, changing the voltage on channel 1 causes the polarization state to rotate about a particular axis on the Poincaré sphere, while changing the voltage on channel 2 will cause it to rotate about an axis orthogonal to that of channel 1, and so on. By independently tuning the control voltages on the 4 channels of the polarization controller, the user can change the output polarization to any state on the Poincaré sphere. Figure 20 shows an example. Point 1 is the initial SOP. From there, the voltages on the 4 channels were sequentially changed in 1-volt steps as follows:

$$\Delta V1 = 10V \rightarrow \text{pt 2}$$

$$\Delta V2 = 15V \rightarrow \text{pt 3}$$

$$\Delta V3 = 20V \rightarrow \text{pt 4}$$

$$\Delta V4 = 20V \rightarrow \text{pt 5}$$

PSY-201 User Guide

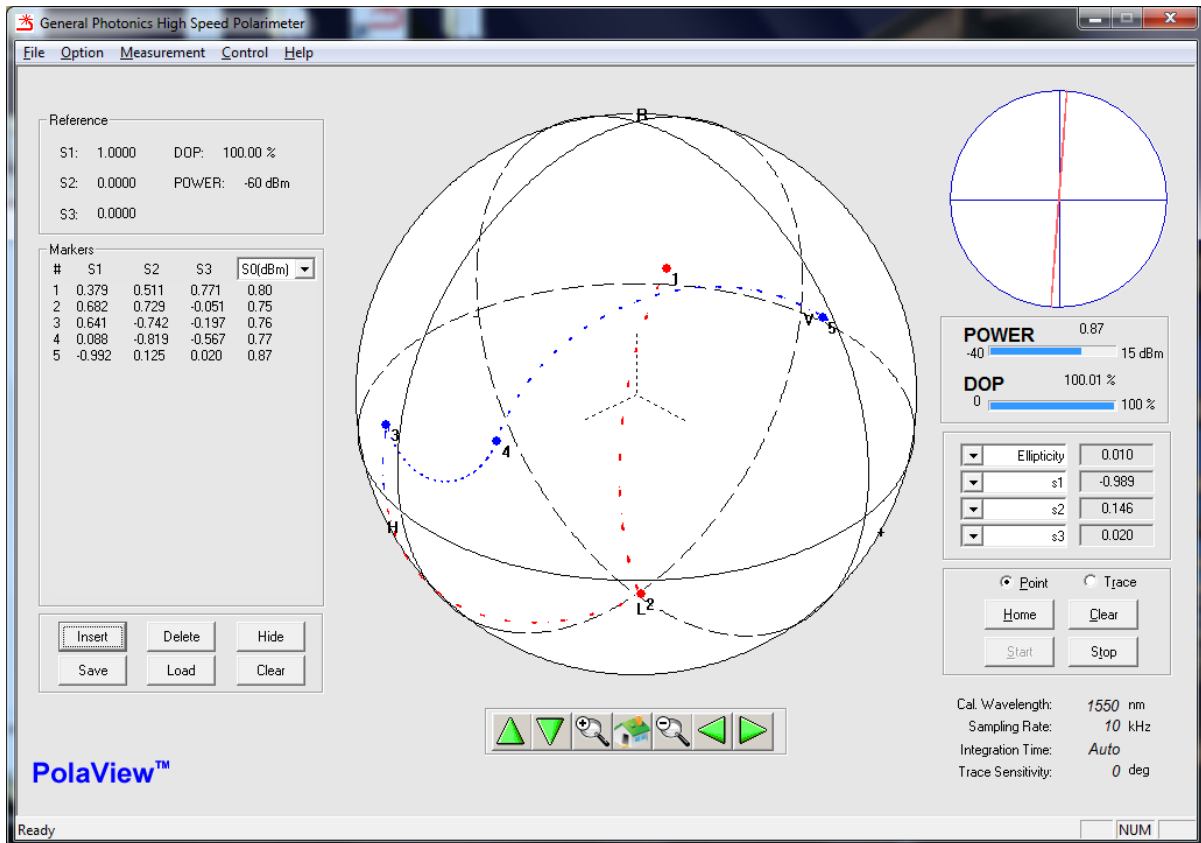
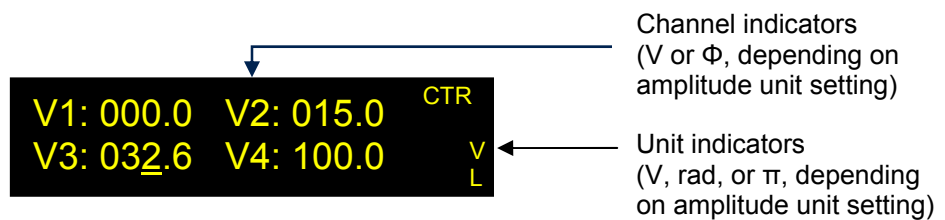

Figure 20 Manual polarization control example

The manual control screen is shown below:



The display screen indicates the current control voltage or retardation for each channel. Use the arrow keys to change settings. The underlined digit is the active one. Pressing ENTER confirms the voltage setting for the selected channel and moves to the next channel. The controls are as follows:

- ▲ : increases or decreases the value of the digit on which the cursor is positioned
- ▼ : decreases or increases the value of the digit on which the cursor is positioned
- ◀ ▶ : moves the cursor position.

ENTER: confirms current channel setting and moves to the next channel.

PSY-201 User Guide

The units for the control signal amplitude can be V, Rad, or n. Units can be changed from the setup menu.

The range for the control signal depends on the selected unit.

	Voltage	n	Radians
Range	0.0 to 150.0	0.00 to 4.00	0.00 to 12.60

The control signal amplitudes change in real time as the ▲ and ▼ arrow keys are pressed.

Track and ■/▶ Buttons

The TRACK button stabilizes the output SOP to its current state. Tracking can be enabled from the measurement screen, in which case it locks the SOP to the displayed value, or from any control mode. For example, an SOP can be set using the manual control mode, and then maintained against input polarization changes using the tracking function. Alternatively, polarization modulation or scrambling can be used to locate a desired polarization state, which can then be locked in using the tracking function.

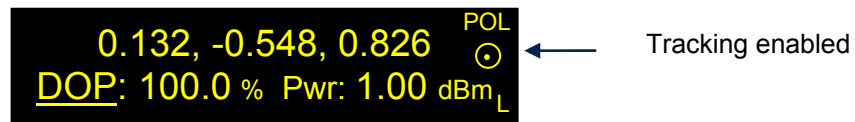

The TRACK button toggles the tracking function on and off. When tracking is enabled, the target indicator appears on the right side of the screen. When tracking is disabled, the PSY-201 restarts the function it was performing when tracking was enabled.

Note that if tracking is invoked using the TRACK button, it must be disabled using the TRACK button (not the ■/▶ button).

For polarization control functions that maintain a single SOP (Track SOP-Stokes, Track SOP-Angle, or Track Basis SOP), the TRACK button function is equivalent to the effect of starting/stopping the function using the ■/▶ button. For pattern generation functions, the ■/▶ button acts as a pause/resume button. When the function is paused, the polarization controller remains in the same setting, but the SOP is not actively maintained against input polarization changes. When the function is resumed, it resumes from that same setting. If the TRACK function is invoked during a pattern generation function, the SOP will be frozen in its current state and maintained against input polarization changes. However, when TRACK is disabled, the pattern generation function generally does not resume from the point at which it was stopped.

Reference

The REF button allows the user to set a reference state (SOP, DOP, optical power), which can be used to monitor changes in these parameters. When the REF button is pressed while there is SOP information on the OLED display, e.g. from the measurement screen or the SOP Storage screen, the instrument will ask whether to set the displayed information as the reference.

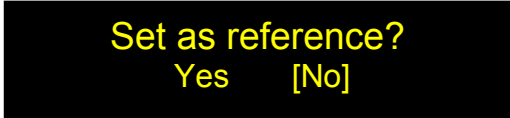

Set as reference?
Yes [No]

Select "Yes" to proceed.

If "No" is selected, or if the REF button is pressed while there is no SOP information displayed on-screen, then the reference menu is shown:



1. Show Current Ref.^{REF}
2. Set to Basis Ref. ↓ L

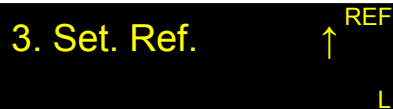

3. Set. Ref. ↑^{REF}
L

1. "Show Current Ref." displays the current SOP, DOP, and Power reference values.

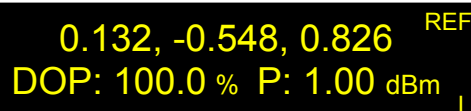

0.132, -0.548, 0.826^{REF}
DOP: 100.0 % P: 1.00 dBm L

Press the ENTER or REF buttons to return to the reference menu.

2. "Set to Basis Ref." allows the user to set one of the basis polarization states as the reference. Use the arrow keys ▼▲▶◀ to select the desired state, and press the ENTER button to confirm the selection. Press the REF button to return to the menu without making a selection.

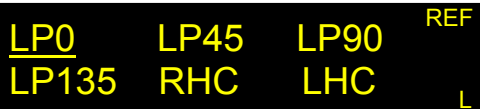

LP0 LP45 LP90^{REF}
LP135 RHC LHC L

PSY-201 User Guide

3. "Set. Ref." allows the user to manually enter Stokes parameters, DOP and power for the reference state. The ◀▶ buttons move the cursor position, and the ▼▲ buttons change the value of the selected digit. The ENTER button confirms the new setting and moves the cursor to the next parameter.

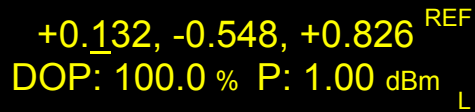

+0.132, -0.548, +0.826^{REF}
DOP: 100.0 % P: 1.00 dBm L

When this function is selected, the cursor will be on the Stokes parameter line. Set all 3 Stokes parameters using the arrow keys, then press ENTER. The Stokes parameters will be normalized, and the cursor will move to the DOP setup position. Repeat the process for setting DOP and power. Press ENTER after setting the power value to store the reference state (SOP, DOP, and power). The cursor will disappear and an "OK" indicator will appear above the "L" in the lower right corner of the screen. Press REF to return to the reference menu.

Store

The STORE function allows the user to store up to 100 sets of SOP, DOP, and Power values. The stored data can either be sets of measured data (serving as a measurement record) or manually entered data (allowing the user to input SOP sequences for the sequence trace function).

When the STORE button is pressed while in polarization measurement mode, the display switches to the storage screen, with the first unused storage ID displayed. Since there is no data stored at this ID#, the data fields will all be zeroes. Press the STORE button again or press ENTER while "Update" is bracketed to store the current set of measured data (SOP, DOP, power) to this location. After the data is stored, the display returns to the polarization measurement screen.

All zeroes in data fields= no data stored at location #2

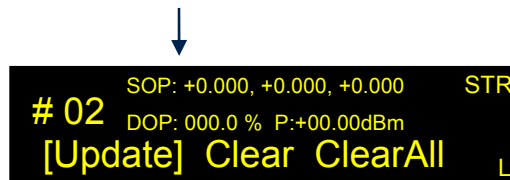

02 SOP: +0.000, +0.000, +0.000 STR
DOP: 000.0 % P: +00.00dBm
[Update] Clear ClearAll L

The ◀▶ buttons can be used to move between the "Update", "Clear", or "Clear All" options. "Clear" will clear the content of the current storage ID, whereas "Clear All" will clear all 100 storage IDs. Pressing the ENTER button will confirm the selection and execute the desired function.

PSY-201 User Guide

From the "Update" option, the ◀ button moves the cursor to the storage ID number, and the user is able to select a storage ID to view or edit. The ID number can be changed using the ▲▼ buttons. While the cursor is on a storage ID number, pressing ENTER moves the cursor to the values stored in the storage ID, allowing the user to manually edit each field within the storage ID. While the cursor is on a parameter, pressing ENTER confirms the parameter value and moves the cursor to the next field. As with the reference setup, the SOP Stokes parameters are treated as one parameter field. Set all 3 Stokes parameters using the arrow keys, then press ENTER to normalize the Stokes parameters and move to DOP.

```
# 01  SOP: 0.132, -0.548, 0.826  STR
      DOP: 99.8% P: -3.00 dBm
Update Clear ClearAll  L
```

Setup

The SETUP button brings up the setup menu for the PSY-201:

```
☞ 1. Wavelength  SET
   2. Units...   ↓  L
```

```
3. Integration Time ↑ SET
4. Analog Outputs ↓  L
```

```
5. Trigger...   ↑ SET
6. Communication... ↓ L
```

```
7. Store Setup... ↑ SET
8. System Info   ↓  L
```

```
9. System Restart ↑ SET
10. Factory Restore L
```

Wavelength

This option sets the operation wavelength by selecting the corresponding calibration matrix for the polarimeter. Use the ▼▲◀▶ buttons to change the values, and press the ENTER button to confirm the setting. If the setting was changed from the previous setting, an "OK" will appear on the right side of the screen to confirm the change. Press the SETUP button to return to the setup menu.

PSY-201 User Guide

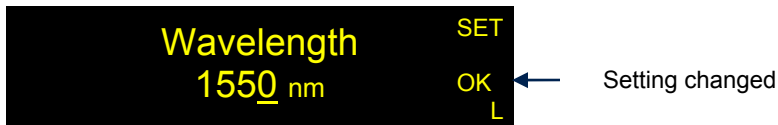

Wavelength range: 1550nm PSY-201: 1480-1620nm Default: 1550nm
 1310nm PSY-201: 1280-1340nm Default: 1310nm

Note: If the PSY-201's operation wavelength does not match the wavelength of the light source, measurement and SOP generation accuracy can be affected. Built-in calibration matrices are spaced at 5nm intervals for the 1550nm PSY-201 and at 2nm intervals for the 1310nm PSY-201.

Units

This option allows the user to select the units used for power and angle in the polarization measurement data display screen, as well as the amplitude units used for polarization modulation and manual control.

Note that the unit settings do not affect other areas of operation such as analog output or threshold trigger setup.

Power

Power Unit sets the units used to display optical power to dBm or mW. Use the ▲▼ buttons to select the desired unit and the ENTER button to confirm the setting. If the setting was changed from the previous setting, an "OK" will appear on the right side of the screen to confirm the change. Use the SETUP button to return to the setup menu (once for unit setup, twice to go to the main setup menu).



Default Power Unit: dBm

Angle

Angle Unit sets the units used to display angle measurements to degrees or radians on the Poincaré sphere. Use the ▲▼ buttons to select the desired units and the ENTER button to confirm the setting. If the setting was changed from the previous setting, an "OK" will appear on the right side of the screen to confirm the change. Use the SETUP button to return to the setup menu.

SET
Angle Unit
Degree
L

Default Angle Unit: degrees

Amplitude

The amplitude unit is the unit used to display the amplitude of the signals applied to the retarders of the polarization control unit inside the PSY-201. The amplitude can be displayed in volts, radians, or multiples of n radians. Radians or n units are calibrated to an accuracy of $\pm 3\%$.

The amplitude unit setting applies to the waveform amplitude and offset in modulation mode and to the settings for each fiber squeezer in manual control mode.

SET
Amplitude Unit
Voltage
L

Default Amplitude Unit: Volts

Integration Time

Integration time refers to the detector integration time used for each SOP sample. The integration time can be set for either automatic or manual control. In automatic control, the integration time is dynamic, with its value determined by the gain, which can change with input power level.

Gain	3dB bandwidth	Average samples	Integration time
0-5	1MHz	4	1 μ s
6,7,8	600kHz	8	2 μ s
9,10,11	100kHz	40	10 μ s
12-18	10kHz	400	100 μ s

SET
Integration Time
Auto
L

Default setting: Auto

PSY-201 User Guide

In manual control mode, the user can set a fixed integration time. The minimum integration time is 0.25 μ s, which corresponds to the highest sampling bandwidth of the PSY-201 (4M SOP samples/second). Both the time value and unit can be changed.

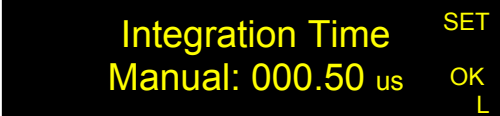

Integration Time SET
Manual: 000.50 us OK
L

Range: 0.25 μ s to 180.00 s

Default: 1 μ s

After entering the integration time setup, use the \blacktriangle \blacktriangledown buttons to select auto or manual integration time control. For manual control, use the \blacktriangleleft \blacktriangleright buttons to move the cursor position to time value or time units, and the \blacktriangle \blacktriangledown buttons to change the value of the selected digit or scroll through unit options.

When finished with integration time setup, press ENTER. If the setting was changed from the previous setting, an "OK" will appear on the right side of the screen to confirm the change.

Analog Outputs

The PSY-201 can output up to 4 monitor voltages that can be configured to monitor different parameters. The DB15 expansion port on the rear panel is used for the monitor voltages. See Figure 7 for the connector pinout.

To configure the analog outputs, use the \blacktriangleleft \blacktriangleright buttons to move the cursor position and the \blacktriangle \blacktriangledown buttons to change the value of the selected digit or parameter.

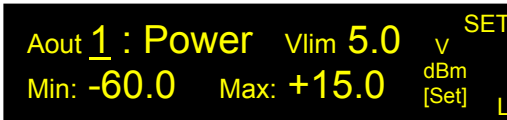

Aout 1 : Power Vlim 5.0 V SET
Min: -60.0 Max: +15.0 dBm [Set] L

Unit indicator
S1, S2, S3: unitless
DOP: %
Power: dBm
dREF: deg

Aout = monitor voltage index. Range: 1 to 4.

Monitor parameter options: power, S1, S2, S3, DOP, dREF

Vlim = upper limit of output voltage range. Range: 0 to 5V.

Min = monitored parameter value that maps to 0V.

Max = monitored parameter value that maps to Vlim.

Ranges for parameter limits:

Power: -60 to +15 dBm (Note: limit setup is in dBm, but monitor voltage still scales linearly with power)

S1/S2/S3: -1 to +1

DOP: 0 to 200%

dREF: 0 to 180.0° (Note: degrees only; cannot be set to radians)

After setting up the monitor voltage parameters, move the cursor to [Set] and press ENTER. An "OK" indicator will appear on the right side of the screen to confirm the setting change.

Resolution: 12-bit DAC, with resolution of 5/4095~1.2mV,

Output voltage settling time: 30ns (10% to 90%)

120ns (Measured to ± 1 mV of final value)

Trigger

The PSY-201 has two measurement trigger options that can be configured from the front panel. Note that the Trigger option in the SETUP menu covers only the measurement triggers, not the scrambling triggers or the tracking trigger.

Input (Measurement) Trigger

"Trigger in" configures the trigger setup for externally triggered SOP measurement. Use $\blacktriangle \blacktriangledown$ to change the value of the underlined parameter, then press ENTER to confirm the selection and move the cursor to the next parameter. An "OK" indicator on the right side shows that the field has been updated. $\blacktriangleleft \blacktriangleright$ can be used to move the cursor without updating the field.

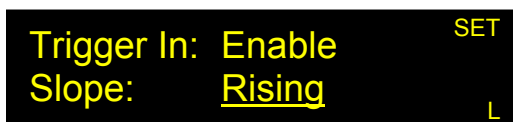

Enable/disable status

Default: Disabled

Slope options: Rising, Falling, R&F

Default: Rising

The slope option determines whether the measurement is triggered on a rising edge, falling edge, or both.

The trigger input uses the BNC connector on the rear panel of the instrument. For each trigger edge, the PSY-201 takes one set of data as set up in the oscilloscope mode of the PolaView software. To use the external measurement trigger, the trigger source in PolaView should be set to "External (TTL)".

Output (dREF) Trigger

The dREF output trigger signal allows the user to monitor SOP deviation from a reference SOP. The dREF threshold defines a circle on the Poincaré sphere around the reference SOP (which is specified using the options accessed by the REF button on the front panel).

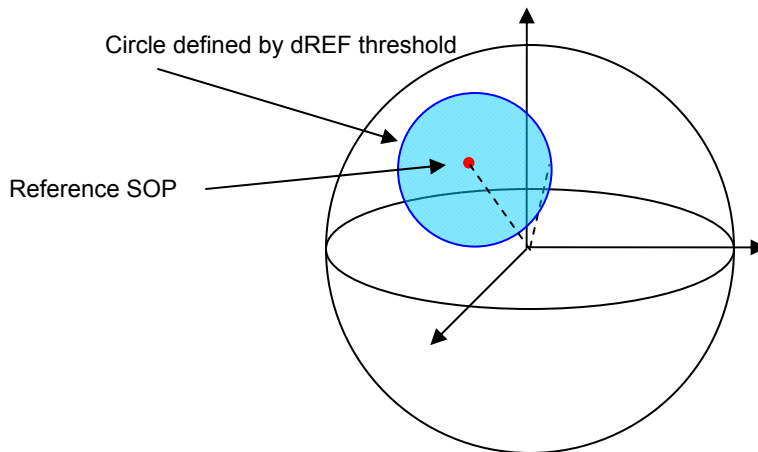

Figure 21 dREF trigger illustration

With the dREF output trigger enabled, the PSY-201 outputs TTL low as long as the measured SOP is within the blue circle, and TTL high when the SOP is outside of the blue circle.

The dREF output trigger signal uses pin 15 on the DB15 expansion port on the rear panel of the PSY-201 (Figure 7).

```

Trigger Out: Enable      SET
Threshold: 000.0°      OK
                        L
    
```

Use ▲▼ to change the value of the underlined parameter or digit, then press ENTER to confirm the selection and move the cursor to the next parameter. An "OK" indicator on the right side of the screen shows that the field has been updated. ◀▶ can be used to move the cursor without updating the field.

Enable/disable status:	Default: disabled
Threshold Range: 0 to 180° from reference SOP on Poincaré sphere	Default: 0°
TTL level low = within threshold	
TTL level high = beyond threshold	

Communication

This submenu allows the user to configure remote control options. In general, we recommend using the front panel, rather than remote control commands, to configure communication options.

PSY-201 User Guide

GPIB

The GPIB option allows the user to set the GPIB address of the PSY-201. Use ◀▶ to move the cursor, ▲▼ to change values, and ENTER to confirm changes. Press SETUP to exit without saving changes. An "OK" indicator on the right side of the screen shows that the field has been updated.

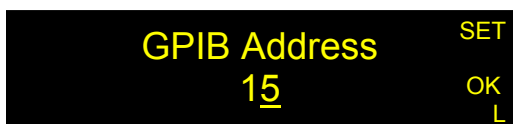

GPIB address range: 1 to 30
Default: 5

TCP/IP

Ethernet communication requires some physical connections as well as instrument configuration. See Appendix 4 for details on physical setup. The TCP/IP option in the setup menu lets the user configure the instrument's IP settings for Ethernet communication. The mode can be set to Static IP or DHCP. Select the preferred mode by using the ▲▼ buttons, then press ENTER.

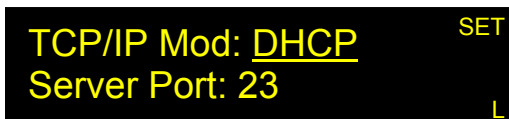

If DHCP is selected, the PSY-201 will be set for dynamic IP addressing and will request an IP address from the server. If the request is successful, the assigned IP address will be displayed.

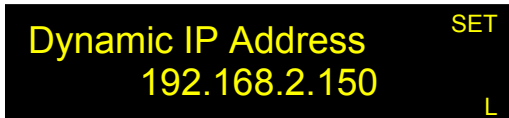

From here, the user can use the SETUP or ▲ buttons to return to TCP/IP setup.

Each time this menu option is selected, the instrument requests a dynamic IP address from the server. If this menu option is selected while the instrument is already in communication using a dynamic IP address, the instrument may be assigned a dynamic IP address other than the one it is currently using. This may interrupt communication, and the address may not be displayed correctly on the front panel.

PSY-201 User Guide

If Static IP is selected, the instrument will go through a series of screens that allow the user to set the IP address, Net Mask, Gateway, and Name Server. After setting each parameter, press ENTER to move to the next parameter. After all parameters have been set, the user will be asked to confirm whether to save the static IP settings. Select "Yes" to update the settings and set the PSY-201 for static IP addressing.

Note: Even if no parameters were changed, it is necessary to select "Yes" on the update screen to set the PSY-201 for static IP addressing.

The instrument retains its TCP/IP mode setting after power-off. However, for dynamic IP addressing, it is still necessary to go to TCP/IP setup and select "DHCP" after the instrument is powered back on, in order to request a dynamic IP address from the server.

RS-232

RS232 sets the baud rate for the serial port. Use the ▲▼ buttons to select the baud rate. Press the SETUP button to exit without change or the ENTER button to confirm a change. An "OK" indicator will appear on the right of the screen to confirm that a change was saved.

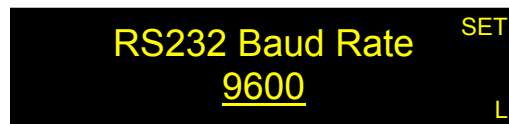

A screenshot of the RS232 Baud Rate menu. The text "RS232 Baud Rate" is displayed in yellow on a black background. Below it, the value "9600" is underlined in yellow. In the top right corner, the word "SET" is written in yellow, and in the bottom right corner, the letter "L" is written in yellow.

Baud rate options: 110, 300, 600, 1200, 2400, 4800, 9600, 19200, 28800,
38400, 43000, 56000, 57600
Default: 9600

EOS

This option allows the user to select the end-of-string indicator for SCPI command strings.

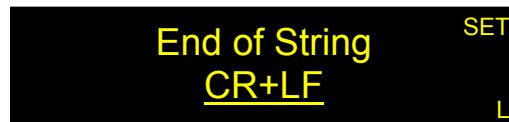

A screenshot of the End of String menu. The text "End of String" is displayed in yellow on a black background. Below it, the value "CR+LF" is underlined in yellow. In the top right corner, the word "SET" is written in yellow, and in the bottom right corner, the letter "L" is written in yellow.

Options: CR + LF
CR (= carriage return)
LF (= line feed)
Default: CR + LF

Use the ▲▼ buttons to change the end-of-string indicator and press ENTER to confirm the setting. An "OK" will appear on the right side of the screen if the setting was changed.

PSY-201 User Guide

Handshake

This option enables or disables GP command response codes (E00, etc.) for SCPI format commands. GP format command responses are always enabled.



Remote Handshake SET
OFF L

Use the ▲▼ buttons to change the setting and press ENTER to confirm. An “OK” will appear on the right side of the screen if the setting was changed.

Default Handshake Setting: Off

Comm Type

The PSY-201 has two available remote control command formats: SCPI, and a General Photonics legacy format.

It is important to match the command type setting to the command format being used. The PSY-201 will not recognize a command that does not match its command type setting.

Use the ▲▼ buttons to change the setting and press ENTER to confirm. An “OK” will appear on the right side of the screen if the setting was changed.



Command Type SET
GP L

Options: SCPI, GP

Default: SCPI

Store Setups

The PSY-201 can store system setups for various experiments or users, which can then be easily recalled for reuse. Note that this is different from the function of the STORE button which is reserved for storing SOP data.

Recall Setup

Recall Setup loads a previously stored system setup to configure the system to a custom user preference. ID#0 is reserved for the factory default setup. Use the ▲▼ buttons to select the ID number. Press the SETUP button to exit without changing system parameters, or press ENTER to change the settings to those stored at the selected ID#. The “OK” indicator will appear on the right of the screen to confirm that the setting has been updated.

PSY-201 User Guide

```
Recall ID: # 0      SET
Note: Default      L
```

Store Setup

Store Setup allows up to 9 user setups to be stored. The Note section can be configured to identify the setup alphanumerically. The Note is 5 characters long; characters can be digits 0-9 or letters A-H. Use ◀▶ to move the cursor and ▲▼ to change values. Press ENTER to save the current setup to the selected ID#, or press SETUP to exit without saving changes. An "OK" indicator on the right side of the screen indicates that the setting has been successfully stored.

```
Store ID: # 1      SET
Note: 000A1      L
```

System Info

System Info displays the serial number, firmware version, and calibration date of the instrument. Press SETUP to return to the setup menu.

```
SN: 15500000067    INF
Fw Ver: V1.3.20141120
Cal Date: 6/10/2015    L
```

System Restart

System Restart restarts the system without power cycling. This is useful if a remote connection is in use and power cycling may cause the connection to be lost.

```
System restart?
Yes    [No]
```

Use ◀▶ to move the cursor to "Yes" or "No" and press ENTER to select.

Factory Restore

Factory Restore restores the system to factory condition: all functions will be reset, user-stored parameters will be erased, and system settings will be reset to default values.

Factory restore?
Yes [No]

Use ◀▶ to move the cursor to "Yes" or "No" and press ENTER to select.

Factory default system settings:

Wavelength:	1550 or 1310nm
Power Unit:	dBm
Angle Unit:	degrees
Amplitude Unit:	Volts
Integration time control:	Auto
Analog Voltage Maximum Output:	5V
Triggers:	Disabled
GPIB address:	5
RS-232 Baud rate:	9600
Static IP Address:	192.168.001.150
Command type:	SCPI
Handshake:	OFF
EOS:	CR+LF

Local

When the PSY-201 receives a remote control command, or is used with the PolaView program, it enters remote mode, which is indicated by an "R" on the lower right hand corner of the screen. In this mode the front panel buttons are disabled to avoid conflict with remote commands. However, if the user wishes to access the front panel buttons while still interfaced to a computer, the LOCAL button can be used to unlock the front panel buttons. The PSY-201 will automatically switch back to remote mode as soon as it receives the next remote control command.

0.132, -0.548, 0.826 POL
DOP: 100.0 % P: 1.00 dBm R

“R” indicates remote, and
“L” indicates local.

3.4 Troubleshooting

Front Panel

1. To ensure stable measurement results, place the setup on a stable surface and fix SM fibers in place.
2. For sensitive measurements, make sure that the input power is within the optimal measurement range (–25 to +10 dBm).
3. Make sure wavelength setting matches wavelength of light source.

Remote Control

Command Format

1. Make sure the "Command Type" setting (SCPI or GP) matches the format of the actual command format to be used.
2. SCPI format: Command strings without an end-of-string (EOS) character will not be executed. If the instrument does not carry out a command and does not beep, it may not have received the EOS character. Make sure that the "Command EOS" setting matches the EOS being used. The default EOS is CR + LF (0D 0A in HEX).
3. GP format: If the beginning ("*") or ending identifiers ("#" or "?") of a command are missing, the instrument will not respond.
4. The instrument will beep to indicate an unrecognized or improperly received command or other error. Check the command format before resending. Commands are case sensitive; for example, :CONTrol and :CONT are ok, but not :CONtrol.

RS-232

1. Make sure that the cable is straight-wired (pin-to-to pin wired) not cross-wired.
2. Verify active Comm Port (COM1, COM2, etc.).
3. Verify Comm Port settings: 8 data bits, 1 stop bit, no parity bits.
4. Make sure baud rate setting on instrument matches baud rate being used by control computer.

USB

1. Make sure that the USB driver is installed before communicating via USB.
2. For the PSY-201, the USB interface is reserved for PolaView. The other interfaces can be used to communicate using the command lists.

Ethernet

1. Make sure that the Ethernet communication setting (Static or Dynamic) matches the Ethernet addressing type being used.
2. Make sure that the cable type is correct: cross-linked cable for static IP with direct connection between computer and instrument, straight-linked cable for connection via a router.
3. Every time "Dynamic IP" is selected from the Settings menu, the instrument requests a new dynamic IP address from the server. If this happens while the instrument is already in communication via dynamic IP, the communication may be interrupted.

PolaView

1. Make sure that the PSY-201 "Command Type" is set to SCPI and the EOS is set to <CR+LF>. PolaView will not work with other command settings.
2. Connect the PSY-201 to the control computer via USB. PolaView does not work with other communication interfaces.
3. Stop measurement before changing measurement setup or parameters. In many cases, PolaView will not respond to menu selections if a measurement is running.
4. Stop measurement and/or close PolaView before powering off the PSY-201.

PSY-201 User Guide

Section 4.0

Specifications

Optical

Operating wavelength range	1480-1620 nm or 1280-1340nm
Sampling rate ¹	Up to 4.0M samples/s
Analog bandwidth ²	1MHz for input > -10 dBm
SOP measurement/generation uncertainty	±0.25° (with user calibration)
DOP measurement uncertainty	±2% (factory calibration) ±0.5% (user calibration)
SOP settling time	1 ms with stable input SOP
Input Stokes parameter resolution	0.001
Operating power range	-35 to 10 dBm
Optical power relative accuracy	±0.1 dB
Optical power measurement uncertainty	±0.25 dB
PER measurement range	0 to 40 dB
PER resolution	0.1 dB
Insertion loss	1.6 dB max at center wavelength
Return loss	55 dB (APC), 45 dB (PC)
PMD	<0.1 ps
PDL	<0.25 dB
Optical power damage threshold	300 mW
SOP stability (for input power > -25 dB, DOP >95%)	0.1° with stable input SOP 0.5° with input SOP variation <2π/s 2° with input SOP variation <10π/s

Electrical/Communication

Front panel display	OLED graphic display
Power Supply	100-240VAC, 50-60 Hz
Trigger In (External Measurement)	TTL pulse, BNC connector rising and/or falling edge (0-5V), user selectable (one set of data per trigger edge, in oscilloscope mode)
Trigger Out (dREF)	TTL level, pin 15 on DB15 expansion port Within threshold: TTL low Beyond threshold: TTL high
Trigger Out (Tracking Status)	TTL level, pin 8 on DB15 expansion port. If dSOP between target and current SOP is Within threshold: TTL low Beyond threshold: TTL high
Trigger In (Random SOP Generation)	TTL rising pulse, pin 13 on DB15 expansion port One SOP per pulse received
Trigger Out (Discrete Scrambling)	TTL rising pulse, pin 14 on DB15 expansion port One pulse per SOP generated

PSY-201 User Guide

Communication Interfaces	USB (PolaView only) RS-232, Ethernet, GPIB
GPIB Address	1-30
RS-232 Baud Rate	110, 300, 600, 1200, 2400, 4800, 9600, 19200, 28800, 38400, 43000, 56000, 57600
USB data transmission rate	30MBps through USB 2.0
Analog output	0 to 5V user configurable monitor voltage for S1, S2, S3, power, DOP, dREF Uses DB15 expansion port
Software	PolaView data analysis/display software

Physical and Environmental

Dimensions	Standard 2U half-19" rack mount size 14" (L) × 8.5" (W) × 3.5" (H)
Fiber Type	Single mode fiber
Fiber Input/Output Connectors	FC/PC, FC/APC, SC/PC, SC/APC
Weight	7.25 lb
Operation temperature	0 to 40°C
Storage Temperature	-20 to 60°C

System

SOP Measurement/Control Functions (front panel)

SOP measurement	s1, s2, s3, Azimuth, Ellipticity, Θ , Φ , dREF, DCP, DLP, DOP, power
-----------------	--

Polarization Control

SOP mapping	Arbitrary (Mapping from any input SOP to any output SOP)
SOP control	Stokes parameters or spherical coordinates
Polarization tracking ³	Reset-free (endless). Quick key tracks to current SOP, or track to a stored or set SOP.

Polarization Scan/Trace Generation

6-state basis generation	Generates the basis states on the Poincaré Sphere: LP0°, LP45°, LP90°, LP135°, RHC, LHC.
SOP sequence generation (up to 100 SOPs)	Step through up to 100 stored SOP points in sequence with specified dwell time at each SOP. Dwell time: 10 ms to 65535 ms
Trace Circle	Circular trace on Poincaré sphere Rotation axes: LP0°, LP45°, LP90°, LP135°, RHC, LHC. Step size range: 0.1° to 180° Dwell time: 10 ms to 65535 ms

PSY-201 User Guide

Polarization Scrambling

Type	Trace	Scrambling Rate Range
Triangle	Continuous	0.01 to 2000 × 2π/s
Discrete	Random, discontinuous points	0.01 to 20,000 points/s
Tornado	Continuous, spiral-type pattern with rotating or fixed spin axis	0.01 to 2000 Rev/s
Triggered	Triggered random state generation	One point per rising TTL pulse

Polarization Modulation

Waveforms	Sine, square, triangle		
Frequency	0.01 to 1000 Hz		
Amplitude	Range (Radian)	Range (n)	Range (V)
	4.71	1.5	45
Offset	Depends on amplitude The relationship between Amp and Ofs is: $Amp \leq Ofs$ Ofs range: A to $(2A_{max} - A)$, where A_{max} is the value listed in the amplitude table		

Notes:

Unless otherwise noted, specifications listed in table apply for standard 1480-1620nm or 1280-1340nm operation at 23±5°C, at power levels > -25 dBm.

- Optimal sampling rate ranges depend on data collection/display mode and setup. Some examples:
 Externally triggered measurement: Sampling rate can be up to 4M points/s.
 PolaView Poincaré sphere mode with trace sensitivity = 0: Sampling rate should be ≤500K points/s for best results.
- Bandwidth may change at lower power levels due to automatic gain control.
- Accuracy depends on input SOP variation speed. See SOP accuracy specification for input SOP variation up to 10π/s.

Appendices

General Photonics provides the PolaView data display/analysis software for the POD-201 and PSY-201. Command lists are also provided for users to write their own control programs. The following appendices include the remote control command lists, setup for different control interfaces, and installation and application procedures for the control software.

Appendix 1.0 Remote Control Commands

The commands and responses listed in Table 1, Table 2, and Table 4 are the same for all communication protocols: RS-232, Ethernet, and GPIB. For the POD-201 and PSY-201, the USB interface is reserved for the PolaView software.

Once the PSY-201 receives a command, it goes into remote control, and the front panel keypad is locked. The control type indicator on the lower right of the screen will show an R. Press the LOCAL button to return to front panel control. The control type indicator will change to L.

The PSY-201 needs to be set to respond to a particular command format before it can receive commands. Use the "Comm Type" setup submenu in the SETUP menu to select SCPI or GP format before sending commands.

For SCPI commands, multiple commands can be concatenated in one string, using semicolons as separators, up to a limit of 128 characters per string.

For GP format commands, only one command string can be sent at a time.

If the PSY-201 beeps after receiving a command, there was a problem with the command. Typically, this happens if the command was incorrectly formatted or does not match the command format setting (for example, the PSY-201 receives an SCPI command while set for GP command format).

Command Lists

SCPI Commands

SCPI command notes:

1. Each command sequence can be turned into a query by using "?" in place of set parameters to check the command's current parameter settings. There is no space between the command sequence and "?".
2. There is a space between a command sequence and a set parameter. Settable parameters are listed in the table using angle brackets < >. There is no space around a channel designation, denoted by <n> in the command list.

Sample command:

:CONT:CHAN1:WAV:TYPE SIN

no space space



PSY-201 User Guide

3. Many command segments can be written out as full words or in pre-defined abbreviated forms consisting of 3 or 4 letters. The abbreviated commands are capitalized in the command sequences listed in the table. E.g. the firmware version query command can be written out as either :SYSTem:VERSion? or :SYST:VERS?
4. Multiple command strings can be concatenated using a semicolon “;”.
5. An end-of-string (EOS) is required to execute a complete command string, the EOS can be configured as Line Feed (LF), Carriage Return (CR), or both (LF+CR).
6. If the instrument beeps after a command is sent, check the instrument’s command type setting (GP or SCPI) and EOS setting to make sure they match the format of the command being sent. Also, check that the command is correctly formatted before resending.
- 7. If the instrument does not carry out a command and does not beep, it may not have received the EOS character. Make sure that the command string ends with the correct EOS. The default EOS is CR + LF (0D 0A in HEX)**

Table 1 SCPI Remote Control Command List

Command Sequence	Parameters	Description/Example
<i>System Information</i>		
:SYSTem:ERRor?		Return error sequence, 20 error messages max, errors read out in FIFO sequence.
:SYSTem:VERSion?		Query firmware version: return value <string> (e.g. V1.3-20141120)
<i>Communication</i>		
:SYSTem:COMMunicate:TYPE?		Query communication protocol type Response: < GP SCPI> or : < 1 0>
:SYSTem:COMMunicate:EOS?		Query End Of String type for SCPI Response: < LF CR CR+LF>
:SYSTem:COMMunicate:HSHake	<1 0>	Set/query handshake enable/disable status. When enabled, PSY-201 responds to SCPI commands with GP format command responses (e.g. *E00#). Default setting: 0 (disabled) :SYST:COMM:HSH 1
:SYSTem:GPIB:ADDRess	<integer>	Set/query GPIB address, range: 1 to 30. Examples: :SYST:GPIB:ADDR 10 :SYST:GPIB:ADDR? Note: Don't use this command while communicating by GPIB.
:SYSTem:NET:IP	<string>	Set/query IP address. :SYST:NET:IP 192.168.001.150
:SYSTem:NET:MASK	<string>	Set/query net mask. :SYST:NET:MASK 255.255.255.000
:SYSTem:NET:GWAY	<string>	Set/query gateway address. :SYST:NET:GWAY 192.168.001.001
:SYSTem:NET:NSERver	<string>	Set/query nameserver. :SYST:NET:NSER 192.168.001.001
:SYSTem:NET:MODE	< SIP DHCP >	Set/query Ethernet mode (SIP = Static, DHCP = Dynamic) :SYST:NET:MODE DHCP

PSY-201 User Guide

:SYSTem:SERial:BAUDrate	<integer>	Set/query RS-232 baud rate. 0: 110; 1: 300; 2: 600; 3: 1200; 4: 2400; 5: 4800; 6: 9600; 7: 19200 8: 28800; 9: 38400; 10: 43000; 11: 56000; 12: 57600 :SYST:SER:BAUD 6 Sample query response: 9600
-------------------------	-----------	---

Note: NET commands (IP, MASK, GWAY, NSERver) are used to set parameters for static IP addressing. However, the query versions will return values for either static or dynamic IP depending on MODE setting.

<i>System Settings</i>		
:SYSTem:LOCK	<1 0>	1: Lock keypad - disable front panel response. 0: Unlock keypad - enable front panel response. Examples: :SYSTem:LOCK 1 :SYSTem:LOCK?
:DISPlay:LOCK	<1 0>	1: OLED display is locked and displays "REMOTE CONTROL." 0: OLED displays current function. Examples: :DISP:LOCK 1 :DISP:LOCK?
:SYSTem:PRESet		Software reset. Reset system settings to factory default: Wavelength:1550 or 1310nm Power Unit: dBm Angle Unit: degrees Amplitude Unit: Volts Integration time: Auto Analog Maximum Output: 5V Triggers: Disabled GPIB address: 5 RS-232 baud rate:9600 Static IP: 192.168.1.150 Command type: SCPI Handshake: OFF EOS: CR+LF
:UNIT:POWer	<dBm mW>	Set optical power units to dBm or mW. Default setting is dBm Examples: :UNIT:POW dBm :UNIT:POW?
:UNIT:ANGLE	<degree radian>	Set angle units to degrees or radians. Default setting is degrees. :UNIT:ANGL? returns Degree or Radian
:UNIT:AMPLitude	<V Radian VPI>	Set the unit of amplitude for retardation control of each channel of the polarization controller. Unit options: volts, radians, multiples of pi Default unit is V. :UNIT:AMPL VPI
:CONFigure:WLENgth	<integer>	Set wavelength in nm. For 1550nm PSY-201: Range:1480 to 1620 Wavelength setting rounds to the nearest multiple of 5. For 1310nm PSY-201: Range: 1280 to 1340nm Wavelength setting rounds to the nearest multiple of 2. :CONF:WLEN 1550

PSY-201 User Guide

:CONFigure:SRATe:SOP	<float>	Set SOP sample rate Unit: Hz. Sampling rate range: 0.02 to 4000000 Hz. Examples: :CONF:SRAT:SOP 100000 :CONF:SRAT:SOP?
:CONFigure:AMODe	<1 0>	Set/query integration time control mode. 0: auto integration time 1: manual integration time Examples: :CONF:AMOD 1 :CONF:AMOD?
:CONFigure:ITIMe	<float>	Set detector integration time. Note: Command only valid in manual mode. Unit us (default), ms, s. If unit is not specified, it is assumed to be us. Query unit is fixed to us Range: 0.25µs to 180s. Examples :CONFigure:ITIMe 1000000 :CONFigure:ITIMe 1000000 us :CONFigure:ITIMe 1000 ms :CONFigure:ITIMe 1 s All of the above commands will set integration time to 1 second.
:CONFigure:REFeRence:SOP	<float1>,<float2>,<float3>	Set reference SOP to (s1,s2,s3) where s1=float1/A s2=float2/A s3=float3/A A=sqrt(f1*f1+f2*f2+f3*f3) Note: f1=f2=f3=0 is not allowed.
:CONFigure:REFeRence:DOP	<float>	Set reference value of DOP (%). Range: 0 to 100 :CONF:REF:DOP 100.00
:CONFigure:REFeRence:POWer	<float>	Set reference power value. Unit is defined by :UNIT:POWer setting Default reference power is 0dBm or 1mW. Power range: -60dBm to 14.909dBm 0.000001mW to 31mW
:CONFigure:GAIN:AGC	<1 0>	Enable/disable automatic gain control. When disabled, the gain is fixed at the latest gain value. 0: AGC is off 1: AGC is on :CONFigure:GAIN:AGC 1
:CONFigure:GAIN	<integer>	Set detector gain Note: Command only valid with AGC off. gain=0, 1, 2,...18. Examples: :CONF:GAIN 3 :CONF:GAIN?
:CONFigure:TRIGger:INPut:EDGE	<0 1 2>	Set/query measurement trigger edge type. 0: rising, 1: falling, 2: rising and falling.
:CONFigure:TRACK:THREShold	<float>	Set dSOP threshold for tracking functions, including tracking trigger. Threshold is defined as a dSOP angle between the target SOP and the current output SOP. Range: 0 to 180 degrees Corresponding tracking trigger output: dSOP <threshold, output: TTL low. dSOP >threshold, output: TTL high.

PSY-201 User Guide

<i>Calibration Matrices</i>		
:CALibration:WType?		Query whether the PSY-201 is a 1310 or 1550nm unit.
:CALibration:CMATrix	<integer>, <float>	Input custom matrix element. integer: matrix element index 1 to 16: 1: m00, 2:m01, 3: m02, 4: m03, 5:m10, 6:m11,16:m33 float: matrix element value Example: :CAL:CMAT 1, 1.000
:CONFigure:CMATrix:MODE	<1 0>	Switch between custom calibration matrix and factory calibration matrix. 1 = custom calibration matrix 0 = factory matrix

Notes: Since a custom matrix must be input one matrix element at a time, it requires 16 commands to input the entire matrix. After the matrix is input, the command :CONFigure:CMATrix:MODE 1 loads it for use.

<i>Polarization Measurement (Single Data Point)</i>		
:MEASure:SOP?		Query measured SOP (Stokes parameters) S1, S2, S3.
:MEASure:SOP:ELLipse?		Query measured SOP (Ellipse angles) Azimuth (AZM) angle range -90 to +90° Ellipticity angle (ELPA) range -45 to +45°
:MEASure:POWer?		Query measured optical power. Result returned in selected units (mW or dBm).
:MEASure:DOP?		Query measured degree of polarization.
:MEASure:DREference:ANGLE?		Query the angle (in degrees) between the reference SOP and the currently measured SOP.
:MEASure:DREference:DOP?		Returns a float value of the difference between the reference DOP and the currently measured DOP.
:MEASure:DREference:POWer?		Returns the power difference in dB between the reference and currently measured values.

<i>Polarization Measurement (Data Set)</i>		
:MEASure:ARRay:NUMBer	<integer>	Set/query number of sample points to collect. Range: 1 to 1000
:MEASure:ARRay:START		Begin collecting data.
:MEASure:ARRay:STATe?		Query sample collection status. 1=collection in process; 0=completed
:MEASure:ARRay:FETCh<n>?		Get the array data for index n: sop, dop, pwr. Units for power are determined by :UNIT:POWer Example: :Measure:Array:Fetch 1? Returns data for array index 1. If there are 100 points in the array, 100 commands are required to fetch all of the data. Note: For this command, there is a space before the index number.

<i>Analog Output</i>		
:OUTPut:ANALog<n>:TYPE	<string>	Configure analog output channel n type. n = 1 to 4. Type options: POW, S1, S2, S3, DOP, or dREF.
:OUTPut:ANALog<n>:MAX	<float>	Set output parameter max value for channel n. n = 1 to 4. Range: DOP: 0 to 100% POW: -60 to +15 dBm S1, S2, or S3: -1.00 to +1.00 dREF: 0 to 180.0°

PSY-201 User Guide

:OUTPut:ANALog<n>:MIN	<float>	Set output parameter min value for channel n. n = 1 to 4. Range: DOP: 0 to 100% POW: -60 to +15 dBm S1, S2, or S3: -1.00 to +1.00 dREF: 0 to 180.0° MIN < MAX
:OUTPut:ANALog<n>:VLEVel	<float>	Set analog output voltage max level. Range: 0 to 5V. Default: 5V.

<i>Polarization Control</i>		
:CONTRol:SOP	<float1>,<float2>,<float3>	Set SOP by Stokes parameters and enable tracking. Stokes parameters are auto-normalized to unit vector before tracking: SOP will be set to (f1/A, f2/A, f3/A) where A=sqrt(f1*f1, f2*f2, f3*f3) Note: f1=f2=f3=0 is not allowed. Example: :CONT:SOP f1,f2,f3
:CONTRol:ANGLE	<float1>,<float2>	Set SOP in spherical coordinates and enable tracking. Ranges: f1=theta: 0 to 360 f2=phi: 0 to 180 Unit: Degrees.
:CONTRol:ANGLE:ELLipse	<float1>,<float2>	Set SOP in ellipse angles and enable tracking. Ranges: f1=azimuth angle: -90 to +90 f2=ellipticity angle: -45 to +45. Unit: Degrees Relation to Stokes parameters: S1=cos(2*ELPA)*cos(2*AZM); S2=cos(2*ELPA)*sin(2*AZM), S3=sin(2*ELPA)
:CONTRol:DISable		Stop active tracking.
:CONTRol:ENABle		Track to current SOP. Equivalent function to TRACK front panel quick key.
:CONTRol:TSCan:TYPE	<integer>	Set axis of rotation for trace scan function: Type: 0: LP0 1: LP45 2: LP90 3: LP135 4: RHC 5: LHC Default: 0 :CONT:TSC:TYPE 1
:CONTRol:TSCan:STEP	<float>	Set trace scan step size Unit: degrees, Range: 0 to 180 Default: 1 :CONTRol:TSCan:STEP 90

PSY-201 User Guide

:CONTRol:TSCan:DWELltime	<integer>	Set dwell time per point for trace scan: Range:10 to 65535 Unit: ms Default 100 Example: :CONTRol:TSCan:DWELltime 100
:CONTRol:TSCan:STATe	<run pause continue restart exit>	Run/pause/continue/restart/exit trace scan Query responses: on/pause/off
:CONTRol:SSCan:DWELltime	<integer>	Set dwell time per point for stored-state scan: Range:10 to 65535 Unit: ms Default 100
:CONTRol:SSCan:RANGe	<integer1>,<integer2>	Set beginning and end locations for stored-state scan. Ranges: 0≤integer1<99, 0<integer2≤99, and integer2>integer1 Note: The SOP sequence for this function can be stored using the ":MEMory:SOP<n>" command.
:CONTRol:SSCan:STATe	<run pause continue restart exit>	Run/pause/continue/restart/exit stored-state scan. Query responses: on/pause/off
:MEMory:SOP<n>	<float1>, <float2>, <float3>	Store SOP (Stokes parameters) in memory location n for stored-state scan. n: 0 to 99 Stokes parameters will be auto-normalized before being stored: s1=float1/A s2=float2/A s3=float3/A A=sqrt(f1*f1+f2*f2+f3*f3) Note: f1=f2=f3=0 is not allowed.
:CONTRol:CHANnel<n>:DC	<float>	Set control retardation of each channel. n: 1 to 4. Ranges: 0 to 150V 0 to 12.6 Radian 0 to 4 Vpi. Units: V, Radian, Vpi, default: V
:CONTRol:CHANnel<n>:WAVEform:TYPE	< SIN TRI SQU>	Set modulation waveform type for channel n: SIN: Sine TRI: Triangle SQU: Square Waveform types are case sensitive.

PSY-201 User Guide

:CONTRol:CHANnel<n>:WAVEform:AMPLitude	<float>	Set modulation waveform amplitude for channel n n: 1 to 4. Ranges: 0 to 45V 0 to 4.71 Rad 0 to 1.49 Vpi. Units: V, RAD, or Vpi. Default: V
:CONTRol:CHANnel<n>:WAVEform:FREQuency	<float>	Set modulation waveform frequency for channel n n: 1 to 4. Range: 0 to 1000.00 Unit: Hz.
:CONTRol:CHANnel<n>:WAVEform:OFFSet	<float>	Set modulation waveform DC offset for channel n. n: 1 to 4. Offset range: A to $2A_{max}-A$ where A_{max} is the amplitude upper range limit for the selected unit (e.g. 75V). Unit: V, RAD, Vpi, default: V
:CONTRol:CHANnel<n>:WAVEform:PHASe	<float>	Set modulation phase offset for channel n. n: 1 to 4. Units: Degree, Radian, Default: Degree Range: 0 to 180° or 0 to pi radians. Phase offset determines starting point for the waveform.
:CONTRol:CHANnel<n>:WAVEform:STATe	<ON OFF>	ON: Enable SOP waveform modulation OFF: Disable SOP waveform modulation
:CONTRol:SCRamble:DISCrete:RATE	<float>	Set discrete scrambling rate. Range: 0.01 to 20000, Unit: points/s
:CONTRol:SCRamble:DISCrete:STATe	<1 0>	1: Enable discrete scrambling 0: Disable discrete scrambling
:CONTRol:SCRamble:TRIangle:RATE	<float>	Set triangle scrambling rate: Range: 0.01 to 2000. Unit: 2Pi/s
:CONTRol:SCRamble:TRIangle:STATe	<1 0>	1: Enable triangle scrambling 0: Disable triangle scrambling
:CONTRol:SCRamble:TORNado:RATE	<float>	Set Tornado scrambling rate: Range: 0.01 to 2000. Unit: Rev/s
:CONTRol:SCRamble:TORNado:STATe	<1 0>	1: Enable tornado scrambling 0: Disable tornado scrambling
:CONTRol:SCRamble:TORNado:TYPE	<0 1>	Set spin axis rotation status: 0 : fixed axis 1: rotating axis
:CONTRol:SCRamble:TRIGger:STATe	<1 0>	1: Enable triggered random SOP 0: Disable triggered random SOP

Note on modulation control: The command :CONTRol:CHANnel<n>:WAVEform:PHASe adds a phase offset to the waveform that shifts the starting point of the waveform. For example, if the waveform on channel 1 is a sine wave, setting the phase (ϕ) of channel 1 to a nonzero value shifts the waveform from $\sin(\omega t)$ to $\sin(\omega t + \phi)$. The phase offset can only be set via this command; there is no front-panel setup for it.

PSY-201 User Guide

Table 2 SCPI Common Commands and Queries (GPIB specific)

These commands are common to all GPIB-enabled devices.

Command	Parameters	Response	Description
*IDN?	n/a	<company>, <model>, <firmware>,<serial>	Product identification query. Response: General Photonics PSY-201, V1.3-20141120, 155000000067
*RST	n/a	n/a	Resets most functions to factory-defined conditions. Each command shows *RST value if the setting is affected.
*TST?	n/a	0 or 1	This command queries the internal self-test when system initiates and returns a result. (0) All tests passed. (1) One or more tests failed.
*ESE	<data> (Range: 0-255)	n/a	Selects the desired bits from the standard Event Status Enable register. The variable <data> represents the sum of the bits that will be enabled. This register monitors I/O errors and synchronization conditions such as operation complete, request control, query error, device dependent error, status execution error, command error and power on. The selected bits are OR'd to become a summary bit (bit 5) in the byte register which can be queried. The setting by this command is not affected by the *RST.
*ESE?	n/a	0 or 1	The Standard Event Status Enable query returns the value of the *ESE Register.
*ESR?	n/a	<value> (Range: 0 - 255)	The Standard Event Status Register query returns the value of the Standard Event Status Register.
*OPC	n/a	n/a	The Operation Complete command sets bit 0 in the Standard Event Status Register when all pending operations have finished.
*OPC?	n/a	0 or 1	The Operation Complete query returns the ASCII character 1 in the Standard Event Status Register when all pending operations have finished. This query stops any new commands from being processed until the current processing is complete. This command blocks the controller until all operations are complete (i.e. the timeout setting should be longer than the longest sweep).
*SRE	<data> (Range: 0-255)	n/a	Sets the value of the Service Request Enable Register. The variable <data> is the decimal sum of the bits that will be enabled. Bit 6 (value 64) is ignored and cannot be set by this command.
*SRE?	n/a	<value> (Range: 0-63 or 128-191)	The Service Request Enable query returns the value of the Service Request Enable Register.
*STB?	n/a	<value> (Range: 0-255)	The Read Status Byte query returns the value of the status byte without erasing its contents.
*PSC	0 or 1	n/a	The Power-On Status Clear command controls the automatic power-on clearing of the Service Request Enable Register, the Standard Event Status Enable Register, and device-specific event enable registers. (1) Enable. (0) Disable.
*PSC?	n/a	0 or 1	The Power-On Status Clear query returns the flag setting as enabled by the *PSC command.

PSY-201 User Guide

*CLS	n/a	n/a	Clear Status. Clears the status byte by emptying the error queue and clearing all the event registers including the Data Questionable Event Register, the Standard Event Status Register, the Standard Operation Status Register and any other registers that are summarized in the status byte.
------	-----	-----	--

Table 3 SCPI Error and Status Codes

Command Errors	
Error code	Description
-100	"Command error": this is the generic syntax error code used if the device cannot detect more specific errors.
-102	"Syntax error": command improperly formatted.
-109	"Missing parameter": values or parameters needed in command are missing.
-110	"Command header error": command does not contain the expected header.
-113	"No header matched": cannot find matched header
-120	"Numeric data error": value or parameter needed in command is out of range or is not a numeric character.
-144	"Characteristic data too long": a command or value/parameter in a command is more than 20 characters.

Device Specific Errors	
Error code	Description
-300	"Device specific error": this is the generic error code used if the device cannot detect more specific errors in device-dependent commands.
-313	"Calibration data lost": indicates error in loading calibration data.
-315	"Configuration data lost" indicates error in loading configuration data.
-350	"Queue overflow": an error occurred but was not recorded because the error queue was full.
-360	"Communication error": this is the generic communication error code used if the device cannot detect more specific errors.
-363	"Input buffer overflow": The command/query is too long.

Operation/Device Control Status Codes	
Code	Description
-500	Device power on: Device sends this code when it powers on or restarts.
-600	"User request event": Device sends this code when it receives a control command via any interface other than GPIB or local front panel keys.
-700	"Request control event": Device sends this code when it receives a control command via GPIB.
-800	Operation completed

GP Format Commands

A GP legacy format command list is available for users who may want to convert programs written for the PSY-101. New PSY-201 functions that were not available in the PSY-101 may not be covered in the GP format command list, so it is generally recommended that SCPI format commands be used to write new programs.

PSY-201 User Guide

Table 4 GP Format Commands

System Information		
Command	Description	Response
*IDN?	Query product number.	*General Photonics,PSY-201,V1.3-20141120,155000000067# or *Enn# if error
*VER?	Query Firmware Version.	*V1.3-20141120# Version dependent
*ADR nn#	Set GPIB address Range: 1 to 30	*E00# if successful else *Enn# error message Example: *ADR 5#
*ADR?	Query GPIB address	*ADR 30#
*IND ON OFF#	Turn on/off the variable label for query responses. E.g. Sample responses to *POW? *POW -6.7# with ind. on *-6.7# with ind. off	*E00# if successful else *Enn# error message
*ADA?	Query the AD average number. ADA = integration time/0.25 μ s	*ADA 3.00# AD avg = 2 ³ =8
*ADA nn#	Set the power factor n that determines the AD average number AD avg = : 2 ⁿ Range for n: 0 to 10 Default: 6	*E00# if successful else *Enn# error message Example: *ADA 6#
*RST#	System reset to default settings.	*E00# if successful else *Enn# error message
*LCD ON OFF#	Enable/disable front panel display update. *LCD ON# → "REMOTE CONTROL" *LCD OFF# → normal display update	*E00# if successful else *Enn# error message
Polarization Measurement		
*POW?	Query measured power. Units determined by power unit setting. Default units: dBm	*POW -6.7#
*POW:UNT?	Query power unit setting (mW or dBm).	*UNT dBm# or *UNT mW#
*POW:UNT MW DBM#	Set power unit to mW or dBm	*E00# if successful else *Enn# error message
*DOP?	Query DOP value, in %.	Example: *DOP 98.6#
*SOP:SSS#	Set SOP query response format to Stokes parameters S1, S2, S3	*E00# if successful else *Enn# error message
*SOP:SANG#	Set SOP query response format to spherical coordinates Theta, Phi	*E00# if successful else *Enn# error message
*SOP:EANG#	Set SOP query response format to ellipse angles Azimuth, Ellipticity angle	*E00# if successful else *Enn# error message
*SOP?	Query SOP value. Response format depends on format command (Stokes parameters, spherical coordinates, or ellipse angles).	*SOP -0.60, 0.60, 0.53# (Stokes) *SOP 87.5,37.9# (spherical coordinates) *SOP 44.2, 25.8 (ellipse angles)
*WAV?	Query wavelength setting Range: 1480-1620 or 1280-1340nm Default: 1550 nm or 1310nm	*WAV 1550#
*WAV nnnn#	Set wavelength in nm. For 1550nm PSY-201: Range:1480 to 1620 Wavelength setting rounds to the nearest multiple of 5. For 1310nm PSY-201: Range: 1280 to 1340nm Wavelength setting rounds to the nearest multiple of 2.	*E00# if successful else *Enn# error message Example: *WAV 1550#

PSY-201 User Guide

Operation Mode		
*MOD?	Query the current mode.	*SOP#: SOP setting *ANG#: angle setting *SPE# special SOP (6 states) *TRA# trace scan *VCT# manual control *RAN# random scramble *SAW# triangle scramble *TOR# tornado scramble *TRG# triggered random SOP *PDS# measurement mode *SAV# s1/s2/s3 save *SET# setup menu *OTH# other modes undefined in the PSY-101, including modulation and stored-state scan
*MOD:zzz#	Set operation mode to zzz. ZZZ: SOP, ANG, SPE, TRA, VCT, RAN, SAW, TOR, TRG, PDS, SAV, or SET	*E00# if successful else *Enn# error message
Polarization Control		
*SOP:SS1 sf.fff#	Set S1 Range: -1.000 to +1.000	*E00# if successful else *Enn# error message
*SOP:SS2 sf.fff#	Set S2 Range: -1.000 to +1.000	*E00# if successful else *Enn# error message
*SOP:SS3 sf.fff#	Set S3 Range: -1.000 to +1.000	*E00# if successful else *Enn# error message
*SOP:THA fff.ff#	Set spherical coordinate Theta Unit: degrees Range: 0.00 to 360.00	*E00# if successful else *Enn# error message
*SOP:PHI sff.ff#	Set spherical coordinate Phi Unit: degrees Range: 0.00 to 180.00	*E00# if successful else *Enn# error message
*SOP:AZM fff.ff#	Set Azimuth angle to fff.ff Unit: degrees Range -90 to +90°	*E00# if successful else *Enn# error message
*SOP:ELP fff.ff#	Set Ellipticity to fff.ff Unitless Range -0 to +1	*E00# if successful else *Enn# error message Note: relationship between ELP and ELPA is $ELPA = \text{atan}(ELP)$, [-45, 45]
*SOP:ELPA fff.ff#	Set Ellipticity angle to fff.ff Unit: degrees Range -45 to +45	*E00# if successful else *Enn# error message
*SOP:ENA ON OFF#	Start or Stop SOP CONTROL	*E00# if successful else *Enn# error message
*SPE:SCN?	Query the dwell time per point for special SOP (6-state) scan.	*SPE:SCN 100#
*SPE:SCN nnnnn#	Set the dwell time per point for special SOP (6-state) scan. Range: 10 to 65535 ms	*E00# if successful else *Enn# error message
*SPE:STA?	Query the special SOP control state	*STA n#
*SPE:STA N#	Special SOP polarization control N= 1: 0° N= 2: 45° N= 3: 90° N= 4: -45° N= 5: RHC N= 6: LHC N= 7: Scan	*E00# if successful else *Enn# error message

PSY-201 User Guide

*TRA:SCN?	Query the trace scanning speed (dwell time per point, in ms)	*TRA:SCN 10# (dwell time = 10 ms)
*TRA:STE n.f#	Set the trace step size, in degrees Default 1° Range: 0 to 180	*E00# if successful else *Enn# error message
*TRA:STE?	Query the step size	*1.5#
*TRA:STA?	Query the trace scan axis N= 0: 0° N= 1: 45 N= 2: 90 N= 3: 135 N= 4: RHC N= 5: LHC Range 0 to 5	*TRA:STA 0#
*TRA:STA N#	Set the trace scan axis N= 0: 0° N= 1: 45 N= 2: 90 N= 3: 135 N= 4: RHC N= 5: LHC Range 0 to 5	*E00# if successful else *Enn# error message
*RAN:ENA?	Query the discrete scrambling enable/disable status.	*RAN:ENA 0 1# 0 = disabled, 1 = enabled
*RAN:FRQ?	Query the discrete scrambling frequency.	*RAN:FRQ 10.00 #
*RAN:FRQ nnnn#	Set the discrete scrambling frequency. Range: 0.01 to 20000 points/s	*E00# if successful else *Enn# error message
*RAN:ENA ON OFF# *RAN:ENA 1 0#	Start or stop discrete scrambling. 1 or ON = enabled.	*E00# if successful else *Enn# error message
*SAW:FRQ?	Query the triangle scrambling frequency. Range: 0.01 to 2000 Units: multiples of 2n/s	*SAW:FRQ 300.10#
*SAW:FRQ FFF.F#	Set the triangle scrambling frequency Range: 0.01 to 2000 Units: multiples of 2n/s	*E00# if successful else *Enn# error message
*SAW:ENA?	Query the triangle scrambling enable/disable status.	*SAW:ENA 0 1# 0 = disabled, 1 = enabled
*SAW:ENA ON OFF# *SAW:ENA 1 0#	Start or stop triangle scrambling. 1 or ON = enabled.	*E00# if successful else *Enn# error message
*MCV n xxx.x#	Set manual control voltage on channel n n: 1 to 4 xxx.x: 0-150.0 xxx.x unit: V	*E00# if successful else *Enn# error message

Communication

*COM:TRG ON OFF#	Enable/disable external measurement trigger	*E00# if successful else *Enn# error message
*GAN?	Query gain value	*6#
*RSX?	Query RS-232 Baud Rate	*9600#

Note on operation modes: ANG mode includes both spherical coordinates and ellipse angles.

PSY-201 User Guide

Table 5 Command Response Codes

E00	No error (Correct command received)
E01	Undefined Command
E06	Parameter outside the allowed range
E07	Character string too long (>buffer limit)
E08	Power too high
E09	Power too low
E11	Error loading stored values
E12	Unable to store state
E13	Storage location invalid
E14	Recall location doesn't exist
E16	Not in setup mode
E17	Mode setup error.
E18	Failed self test
E50	Stoke values square sum is out of range.

Programming Notes for PSY-101 Users

Although the GP format command list is provided for backward compatibility, because of changes to the structure of the PSY-201 relative to the PSY-101, there are some differences in how some of the commands work.

The major change is the definitions of θ and ϕ used for angle definition of SOPs.

In the PSY-101, θ was defined as the orientation (also known as azimuth) angle and ϕ as the ellipticity angle of the polarization ellipse.

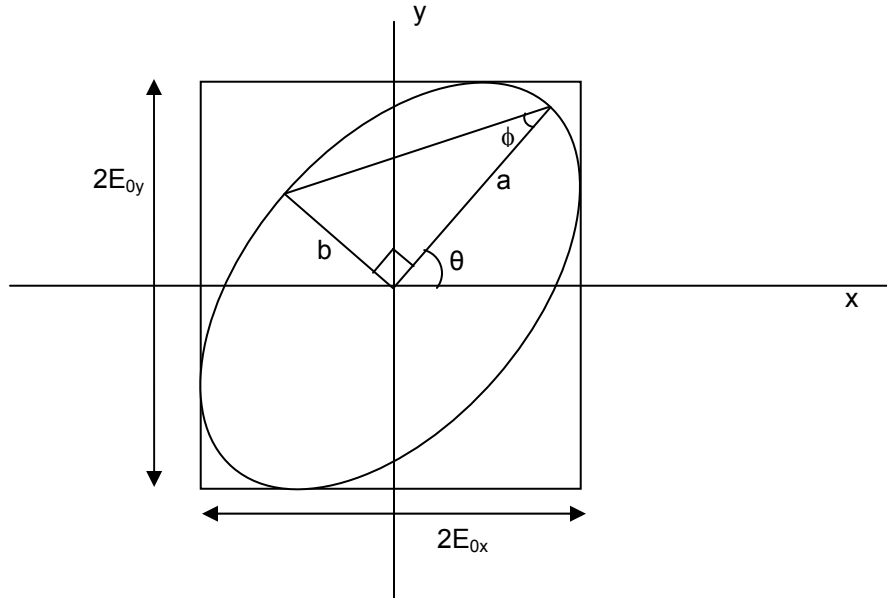

Figure 22 Polarization ellipse, labeled with PSY-101 angle definitions

For a light beam with propagation direction z (out of the paper) and polarization ellipse as shown in Figure 22, with semimajor axis $a >$ semiminor axis b , the azimuth angle θ is defined as the angle between the x axis and the semimajor axis of the ellipse. The ellipticity angle ϕ is defined by

$$\tan \phi = \pm \frac{b}{a}$$

where the positive sign is used for right-handed rotation, and the negative sign for left-handed rotation. The range for θ in the PSY-101 is 0° to 180° , while the range for ϕ is -45° to $+45^\circ$.

On the Poincaré sphere, the corresponding position is:

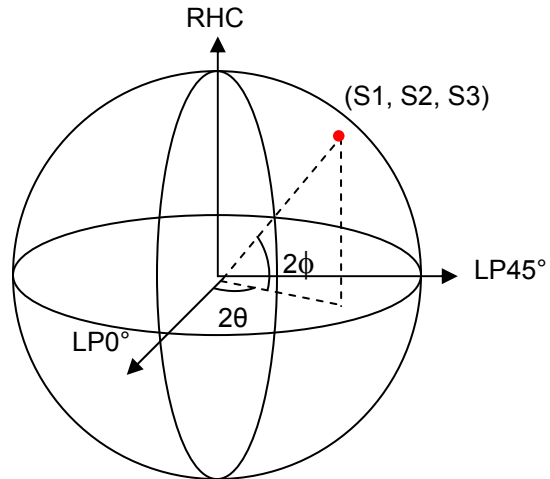

Figure 23 PSY-101 ellipse angles on Poincaré sphere

In the PSY-201, the polarization ellipse angles have been relabeled. The azimuth angle is now denoted by AZM, and the ellipticity angle by ELPA. However, the range for AZM in the PSY-201 is -90 to $+90^\circ$, rather than 0 to 180° , as it was for the PSY-101.

In the PSY-201, θ and ϕ are used to denote spherical coordinates on the Poincaré sphere.

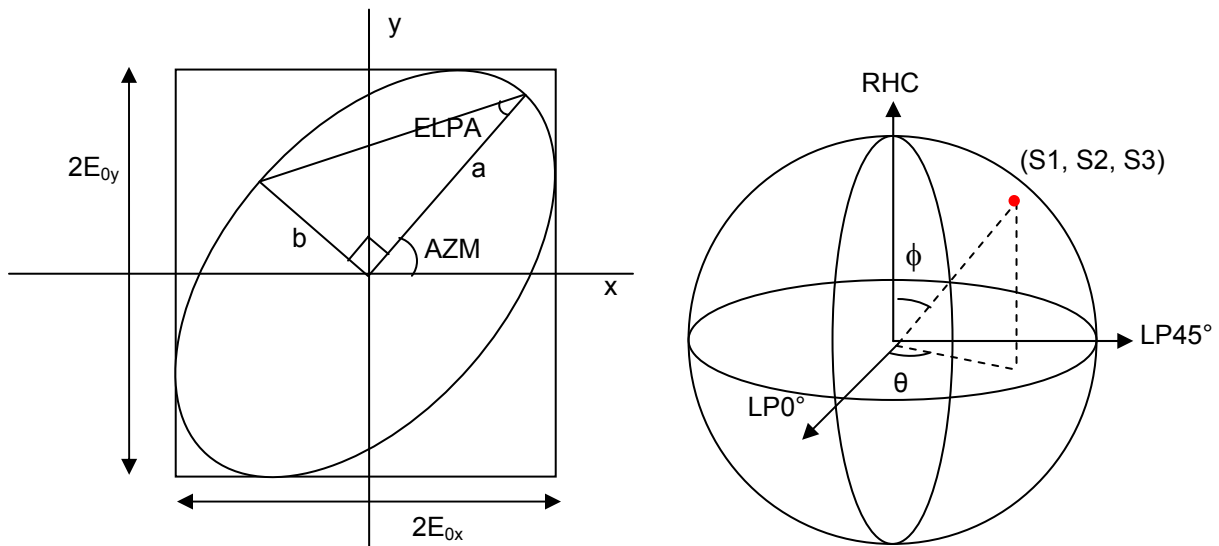

Figure 24 PSY-201 ellipse angles and spherical coordinates

Therefore, if we denote the PSY-101 angle definitions as θ_1 and ϕ_1 , and the PSY-201 angle definitions as θ_2 and ϕ_2 , then the conversions are:

For $0 < \theta_1 \leq 90^\circ$

$$\theta_2 = 2\text{AZM}$$

$$\text{AZM} = \theta_1$$

For $90 < \theta_1 < 180^\circ$

$$\theta_2 = 2(\text{AZM} + 180^\circ)$$

$$\text{AZM} = \theta_1 - 180^\circ$$

PSY-201 User Guide

$$\phi_2 = 90 - 2\text{ELPA}$$

$$\text{ELPA} = \phi_1$$

For the PSY-101, the user could set or query the SOP using either Stokes parameters or ellipse angles.

The PSY-201's GP format command list allows the user to set or query the SOP using Stokes parameters, spherical coordinates or ellipse angles. However, because of the changes in range and terminology, PSY-101 users will have to modify programs that use the polarization ellipse angles.

PSY-101	PSY-201	Command Function
*SOP:ANG#	*SOP:EANG#	Format response to SOP query as ellipse angles
*SOP?	*SOP?	SOP query. The query is the same, but the response format for ellipse angles is different. PSY-101: *THA 100,PHI 20# PSY-201: *SOP 100,20#
*SOP:THA fff.ff#	*SOP:AZM fff.ff#	Set polarization ellipse azimuth angle. Angle conversions: For $0 < \theta_1 \leq 90^\circ$, $\text{AZM} = \theta_1$ For $90 < \theta_1 < 180^\circ$, $\text{AZM} = \theta_1 - 180^\circ$
*SOP:PHI sff.ff#	*SOP:ELPA fff.ff#	Set polarization ellipse ellipticity angle. Range: -45 to $+45$ degrees for both PSY-201 and PSY-101.

Other differences in the command lists:

1. Manual control: In the PSY-201, the user can adjust the control voltages to 4 channels of the polarization controller, not 6. Any commands to control channels 5 or 6 need to be removed.
2. The PSY-201 does not have the *ADV:MAX n# command. If this command was used in a program, it must be removed.
3. The mode options are different, so if a program uses the *MOD? or *MOD n# commands, the user needs to be aware that these may need to be changed.
4. The setup for the trace scan is different, because the available trace scan axes are different in the PSY-101 and PSY-201. Programs that use the trace scan function may need to be changed accordingly.

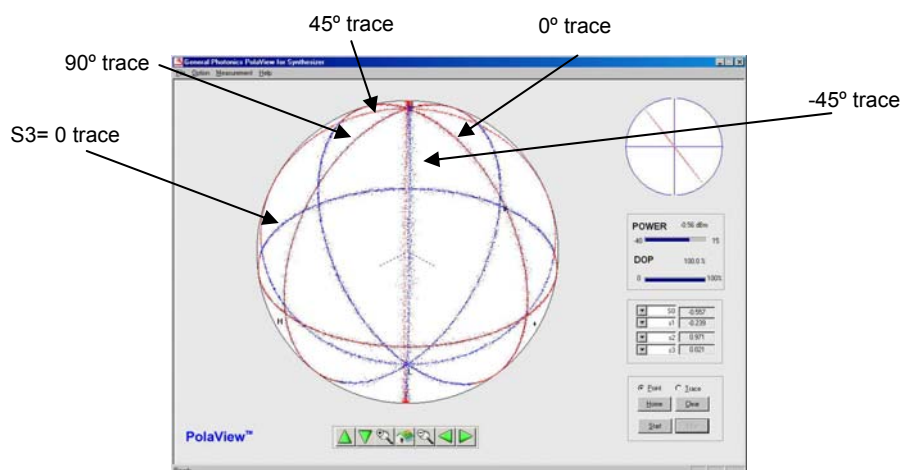
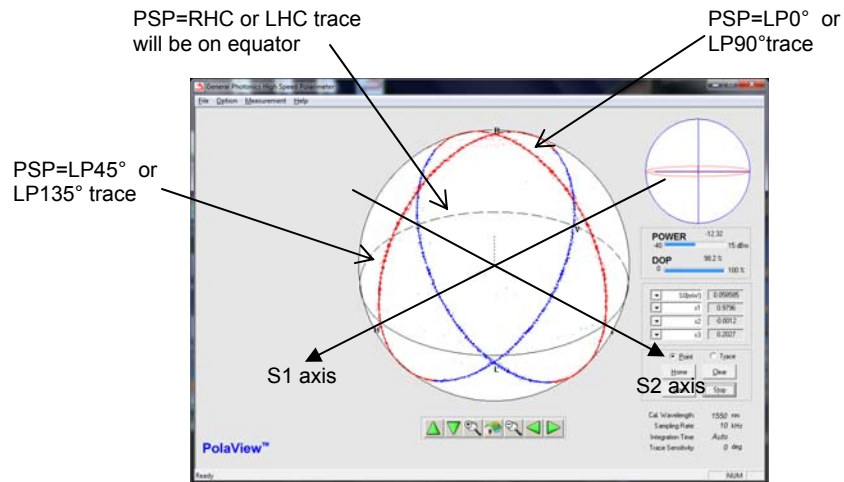

Figure 25 PSY-101 trace scan options: n = 1 (0°), 2 (45°), 3 (90°), 4 (-45°), 5 (S3=0).

PSY-201 User Guide



**Figure 26 PSY-201 trace scan options: n = 0 (0°), 1 (45°), 2 (90°), 3 (135°), 4 (RHC), 5 (LHC).
 0° and 90° trace the same pattern in opposite directions.
 45° and 135° trace the same pattern in opposite directions
 RHC and LHC trace the same pattern in opposite directions (around the equator)**

5. The response formats for some query commands have changed, especially with indicators on. Programs may need to be changed accordingly. Some examples:

Query	PSY-101 Response Format	PSY-201 Response Format
*SOP?	*S1 -0.60,S2 0.60,S3 0.53# or *THA thetavalue,PHI phivalue#	*SOP -0.60, 0.60, 0.53# (Stokes) *SOP 87.5,37.9# (spherical coordinates) *SOP 44.2, 25.8 (ellipse angles)
*SPE:SCN?	*SCN nnnnn#	*SPE:SCN nnnnn#
*TRA:SCN?	*SCN nnnnn#	*TRA:SCN nnnnn#
*TRA:STE?	*STE n.n#	*n.n#

Appendix 2.0 RS-232 connection and setup

1. The RS-232 connector on the rear panel of the PSY-201 is a DB9 male connector. Use a straight (not cross connected) RS-232 cable with DB9 female connectors to connect the PSY-201 to the control computer.

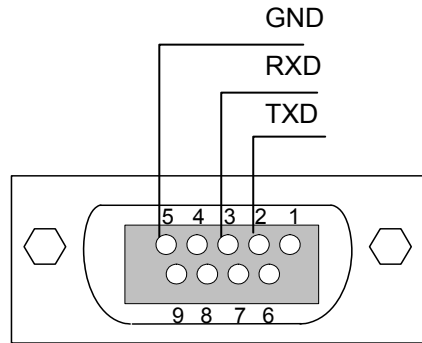

Figure 27 RS-232 connector pin assignment on PSY-201 rear panel.

2. Power on the instrument.
3. Set the RS-232 baud rate. SETUP → Communication → RS232. Make sure it matches the baud rate setting of the control computer.
4. Select the command type (SETUP → Communication → Comm Type) and, for SCPI, command EOS.
5. Send a command string to the instrument (See Appendix 1 for commands. Any program that supports RS-232 communication protocols can be used to send ASCII commands to the instrument. Many programming languages support serial communications, including Visual Basic, LabView and C.

RS-232 settings:

RS-232 port uses asynchronous framing, 8 data bits, no parity bit, and 1 stop bit.

RS-232 baud rate: configurable. Default is 9600 bps.

Appendix 3.0 USB connection and setup

USB control requires installation of a USB driver.

Run the Setup file on the shipping cd to install the PolaView software. This will also copy the USB drivers to the control computer. After the setup is finished, connect the PSY-201 to the computer with a USB cable and power on the PSY-201. The USB driver should install automatically (follow instructions on the installation wizard). If the driver cannot be found, install it manually, select "browse for location", and point it to the "Driver" folder (with "include subfolders" checked).

Note: The USB driver installed by the PolaView setup file supports the high speed USB used by PolaView. It cannot be used for sending single commands via terminal emulation programs such as HyperTerminal.

Appendix 4.0 Ethernet setup

There are two connection configurations for Ethernet control:

- a) Static IP: the administrator assigns the instrument a fixed IP address. In this mode the instrument can be directly connected to the control PC, as shown in Figure 28. For this configuration, a cross-linked network cable must be used. Note: Static IP can also be used with the instrument connected to a router. In this case, a straight-linked network cable would be used.
- b) Dynamic IP: the DHCP server assigns the instrument an available address when requested. Connect the instrument with a DHCP server (running on router or exchange server), as shown in Figure 29. For this configuration, a standard straight-linked network cable must be used.

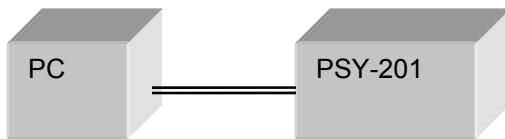

Figure 28 Direct connection: PSY-201 to PC

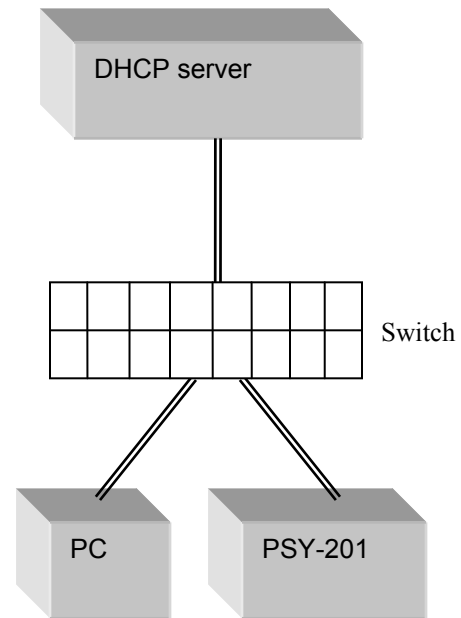

Figure 29 Connection with DHCP server

Once the physical connections are established, the instrument's Ethernet configuration can be set up from the front panel.

PSY-201 Setup for Ethernet communication:

Selecting "DHCP" in the TCP/IP setup section of the setup menu sets the PSY-201 for dynamic IP addressing and requests a dynamic IP address from the DHCP server. Selecting "Static IP" allows the user to set the PSY-201 for static IP addressing and to set the static IP address, net mask, gateway, and name server. See section 3.3 for a more detailed description. Note that even if no settings were changed, it is necessary to go through all of the static IP setup screens and select "Yes" on the update confirmation screen in order to set the communication mode for static IP.

The PSY-201 writes its most recently saved static IP settings and its active mode to memory. If it is powered off while in static mode, when it is powered back on, it will be in static mode, and the most recently saved set of IP configuration information can be used for communication.

If the PSY-201 is powered off while in dynamic IP mode, when it is powered back on, it will be in dynamic IP mode. However, it is still necessary to use the "Dynamic IP" function in the setup menu to request a new dynamic IP address.

For static IP control, the net mask and gateway for the instrument should be the same as those for the control computer. The first 3 groups of numbers in the IP address should be the same as those for the control computer (192.168.2, for example). The last number can be any available number, but cannot be the same as the IP address of the control computer. The range of numbers is 1 to 254. If the computer's IP address is 17, for example, the user can set the IP address for the PSY-201 to any number in the range 1-254 except 17.

For static IP control, make sure that the control computer is also set to use a static (defined) IP address (check the TCP/IP properties to find the computer's Ethernet setup information).

For dynamic IP control, make sure that the control computer is set to obtain its IP address automatically. This information is also under TCP/IP properties.

- To connect the instrument directly to a PC, use a PC to PC cable. To connect the instrument to a LAN, use a standard network cable.

Appendix 5.0 GPIB setup and control

Setting the GPIB Address

To set the instrument's GPIB address:

Press the SETUP button → Select Communication (option 6) → Select GPIB (option 6.1).

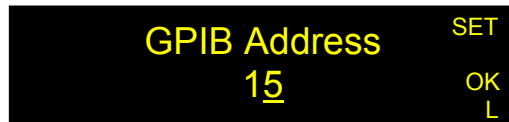

Use ◀▶ to move the cursor and ▲▼ to change values. Press ENTER to confirm the change, or press SETUP to exit without saving changes. An "OK" indicator on the right of the screen shows that the field has been updated.

Range: 1-30

Default: 5

GPIB control

Connect the instrument to the computer with a GPIB cable. After determining/setting the PSY-201's GPIB address, enter the GPIB address in the communication program being used. The instrument will then be ready to receive commands. The command lists is given in Appendix 1. The command lists, responses, and error codes are given in Table 1 through Table 5 in Appendix 1.

To ensure proper communication, use a GPIB cable that is fully compatible with the IEEE 488.1 standard. All GPIB/IEEE 488 interface connections must be made before turning on the instruments.

Appendix 6.0 PolaView data display/analysis program

The PolaView data analysis and display software provides real-time graphic display of polarization state either on a Poincaré Sphere window for viewing SOP traces or on an oscilloscope window for tracking polarization changes over time.

Measurable polarization parameters are defined as follows:

SOP: State of polarization of light, expressed in normalized Stokes parameters S_0 , s_1 , s_2 , and s_3 .

The Stokes parameters are related to the electric field by

$$S_0 = E_{0x}^2 + E_{0y}^2$$

$$S_1 = E_{0x}^2 - E_{0y}^2$$

$$S_2 = 2E_{0x}E_{0y} \cos \delta$$

$$S_3 = 2E_{0x}E_{0y} \sin \delta$$

where δ is the relative phase between the two orthogonal electric field components.

They are calculated from measured values by

$$\begin{bmatrix} S_0 \\ S_1 \\ S_2 \\ S_3 \end{bmatrix} = M \begin{bmatrix} V_0 \\ V_1 \\ V_2 \\ V_3 \end{bmatrix} = \begin{bmatrix} m_{00}, m_{01}, m_{02}, m_{03} \\ m_{10}, m_{11}, m_{12}, m_{13} \\ m_{20}, m_{21}, m_{22}, m_{23} \\ m_{30}, m_{31}, m_{32}, m_{33} \end{bmatrix} \begin{bmatrix} V_0 \\ V_1 \\ V_2 \\ V_3 \end{bmatrix}$$

where $V_0 \sim V_3$ are analog output voltages from the polarimeter, M is a calibration matrix, and $S_0 \sim S_3$ are the Stokes parameters corresponding to $V_0 \sim V_3$.

The PSY-201 provides normalized Stokes parameters defined as follows:

S_0 is the measured power.

$$s_1 = \frac{S_1}{\text{norm}(\vec{S})}$$

$$s_2 = \frac{S_2}{\text{norm}(\vec{S})}$$

$$s_3 = \frac{S_3}{\text{norm}(\vec{S})}$$

$$\text{where } \text{norm}(\vec{S}) = \sqrt{(S_1)^2 + (S_2)^2 + (S_3)^2}$$

PSY-201 User Guide

s_1 , s_2 , and s_3 are the Stokes parameters normalized to the surface of the sphere. They satisfy the normalization condition

$$s_1^2 + s_2^2 + s_3^2 = 1.$$

DOP: Degree of polarization of light

$$DOP = \frac{norm(\vec{S})}{S_0}$$

dREF: The angle between the current SOP and the reference SOP

$$dREF = \frac{180}{\pi} \cos^{-1}(s_1 * s_1^{ref} + s_2 * s_2^{ref} + s_3 * s_3^{ref})$$

where s_1 , s_2 , and s_3 are the normalized Stokes parameters of the current SOP and s_1^{ref} , s_2^{ref} , and s_3^{ref} are the normalized Stokes parameters of a reference polarization state specified by the user.

DLP: Degree of linearity

$$DLP = \frac{\sqrt{(S_1)^2 + (S_2)^2}}{S_0}, \quad 0 \leq DLP \leq 100\%$$

DCP: Degree of circularity

$$DCP = \frac{S_3}{S_0}, \quad 0 \leq DCP \leq 100\%$$

Azimuth and ellipticity refer to the polarization ellipse.

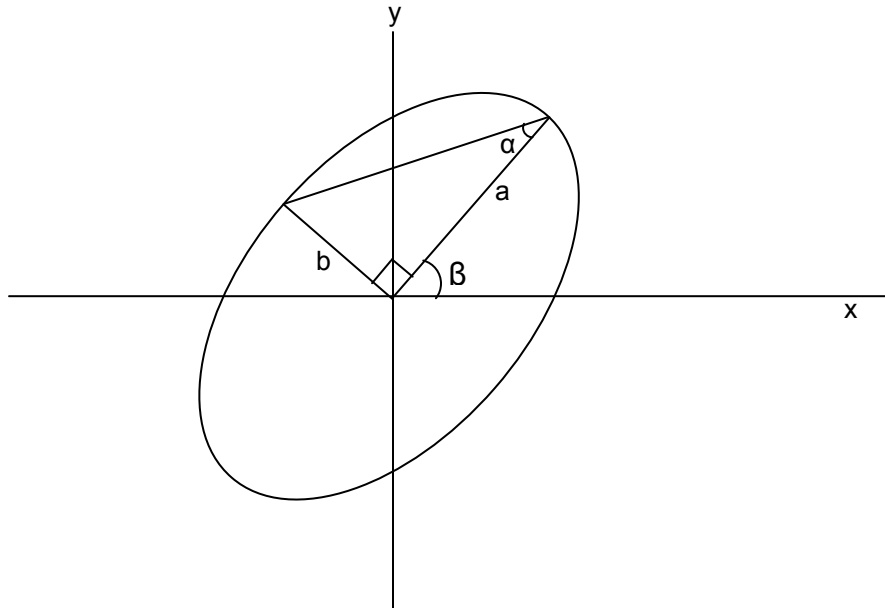

Figure 30 Polarization ellipse

PSY-201 User Guide

For a light beam with propagation direction z (out of the paper) and polarization ellipse as shown in Figure 30, with semimajor axis $a >$ semiminor axis b , the azimuth is defined as the angle between the x axis and the semimajor axis of the ellipse. The ellipticity is defined as

$$\text{Ellipticity} = \tan \alpha = \pm \frac{b}{a} = \tan \left(\frac{1}{2} \sin^{-1} \left(\frac{S_3}{\text{norm}(\vec{S})} \right) \right)$$

where the positive sign is used for right-handed rotation, and the negative sign for left-handed rotation. The range for β is 0° to 180° , while the range for ellipticity is -1 to 1 . Ellipticity = -1 for LHC, 0 for linear, and $+1$ for RHC polarization states.

Azimuth angle β

When $-\pi/2 < \tan^{-1}(x) < \pi/2$:

- $s_1 > 0$, $\beta = \frac{1}{2} \Theta$
- $s_1 < 0, s_2 > 0$ $\beta = \frac{\pi}{2} + \frac{1}{2} \Theta$
- $s_1 < 0, s_2 < 0$, $\beta = -\frac{\pi}{2} + \frac{1}{2} \Theta$
- $s_1 = 0, s_2 > 0$, $\beta = \frac{\pi}{4}$
- $s_1 = 0, s_2 < 0$, $\beta = -\frac{\pi}{4}$
- $s_1 = 0, s_2 = 0$, $\beta = 0$

where Θ is a spherical coordinate angle on the Poincaré sphere.

The following sections refer to PolaView V2.501 and above.

Instrument Compatibility

The PolaView software can be used with either the POD-201 polarimeter or the PSY-201 polarization synthesizer. When the program is started, it detects which instrument is connected and enables or disables functions accordingly.

System Requirements

1. Monitor resolution : 1024×768 and above
2. Memory: 512 Mb
3. Operating System: Windows XP, Windows 7, Windows 8
4. Computer chip : Intel Pentium 4 or equivalent configuration
5. Communication Port : USB 2.0

Software Installation

The PolaView software uses a USB connection to the PSY-201, so it requires that the USB driver be installed.

To install the PolaView software, run the file "setup.exe" on the provided CD. Follow the directions in the installation wizard. The setup file will install the PolaView software and create shortcuts to it on the desktop and Start menu. It will also copy the USB drivers to the computer.

Once the PolaView installation is complete, connect the PSY-201 to the computer with a USB cable and power on the instrument. This should trigger installation of the USB driver.

Software Removal

The software can be removed from the "Add or Remove Programs" section of the control panel.

Setup

1. Connect the POD-201 or PSY-201 to the control computer with a USB cable. Power on the instrument.
2. Press the SETUP button on the front panel, and go to the communication setup menu. Make sure that the instrument's Comm Type setting is set to SCPI, and the EOS is set to CR + LF. If either of these settings is incorrect, PolaView will not be able to communicate with the instrument.
3. Start the PolaView program.

The PolaView software can be used with either the POD-201 polarimeter or the PSY-201 polarization synthesizer. When the program is started, it detects which instrument is connected and enables or disables functions accordingly.

There are two data display and acquisition modes: Poincaré Sphere mode and oscilloscope mode (Under the "Measurement" menu). Measurement must be stopped (click "Stop" in the lower right hand corner of the screen) to change display modes or use any of the menu functions. Sphere mode is the default data display mode when the software is started.

Poincaré Sphere Display

Figure 31 shows the user interface for sphere display mode. A data point's location on the 3-D sphere is determined by vector (s_1, s_2, s_3) . R (0,0,1), and L (0,0, -1) denote the sphere poles corresponding to right hand circular and left hand circular polarizations, respectively.

The 2D circle at the top right of the screen displays the SOP ellipse. The power level (in dBm) and DOP (in %) are displayed immediately below the 2D circle. There are 4 configurable parameter display boxes immediately below the DOP bar. Each of these parameter displays have pull-down menus that allow the user to select azimuth, ellipticity, DLP, DCP, dREF, and DOP as well as S-parameters.

PSY-201 User Guide

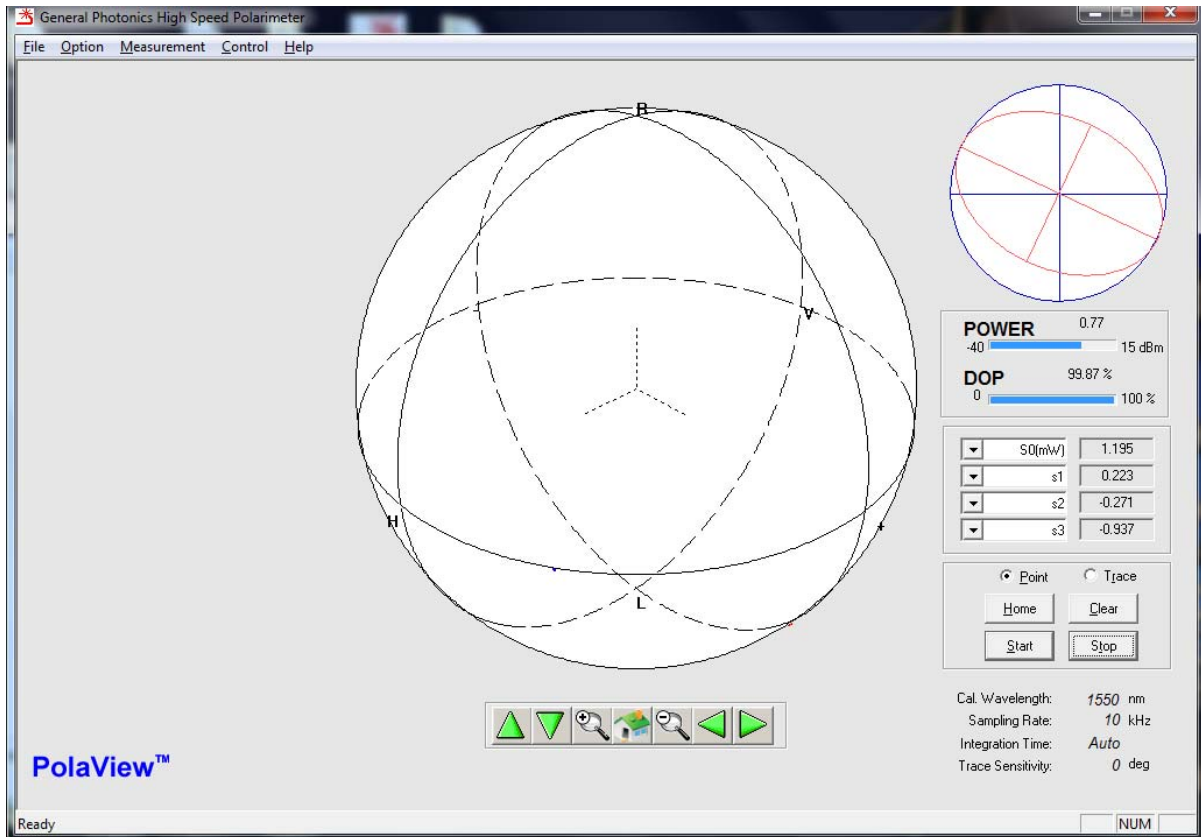
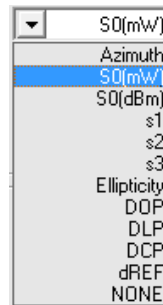

Figure 31 Poincaré Sphere display



Parameter display selection

Sphere display mode uses continuous data acquisition. The data acquisition process begins and data points appear on the sphere when the user clicks the “Start” button. The process runs until the “Stop” button is clicked. “Clear” clears all displayed data points from the sphere. The display can also be switched between “Point” (displays individual points) and “Trace” (links consecutive data points on the sphere to display a trace). Points on the front of the sphere are displayed in red, and points on the back of the sphere in blue.

The sphere can be rotated for different vantage points using the green arrow buttons at the bottom of the screen. The magnifying glass buttons at the bottom of the screen zoom the

PSY-201 User Guide

sphere in or out. Both the house button at the center bottom of the screen and the "Home" button immediately above the "Start" button return the sphere to its default position and size.

The sphere display buffers 100,000 points. Therefore, if the sphere is rotated, only the most recent 100,000 points will be retained.

The section at the bottom right of the screen displays the primary operation parameter settings for the SOP measurement.

Cal Wavelength:	Wavelength of currently loaded calibration matrix (default 1550 or 1310nm)
Sampling Rate:	SOP sampling rate setting (default: 10 kHz)
Integration Time:	Automatic or manually set integration time (default: auto)
Trace Sensitivity:	Minimum SOP resolution, in degrees, for displayed SOP data; determines data capture rate (default: 0°)

Oscilloscope Display

Figure 32 shows the oscilloscope mode user interface. There are four virtual oscilloscope windows that allow the user to monitor the time evolution of polarization parameters.

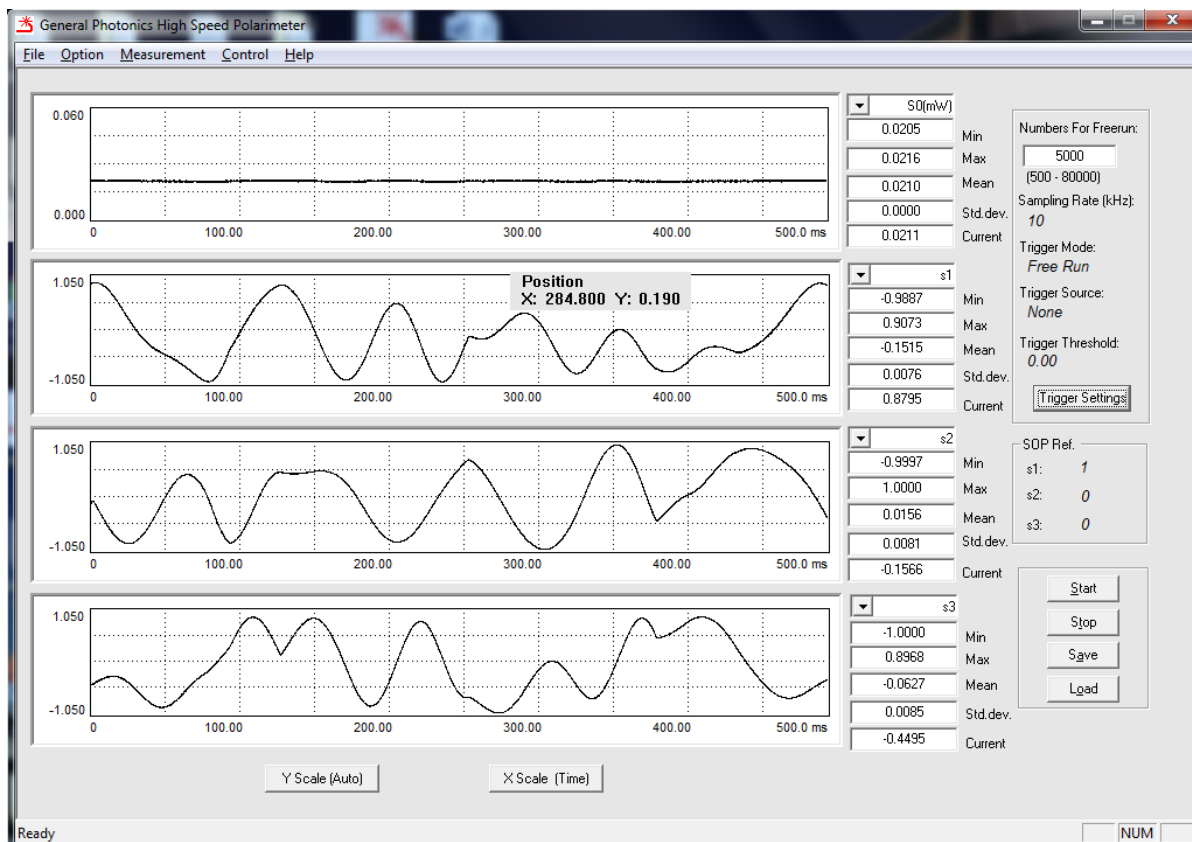

Figure 32 Oscilloscope display

The oscilloscope display area resembles an electronic oscilloscope. The pull-down menu at the top right of each data display area is used to select the parameter displayed in the

PSY-201 User Guide

corresponding oscilloscope trace and data display area. Parameters that can be monitored include S_0 (power), s_1 , s_2 , s_3 (normalized Stokes parameters), Azimuth, Ellipticity, DOP (degree of polarization), DLP (degree of linearity), DCP (degree of circularity) and dREF (angle variation of the current point from the reference point). The "X-Scale" button at the bottom of the screen toggles the x-scale unit between sample point number and time in ms. The "Y-Scale" button function will be described in the Option Menu section, since this function is also accessible from the Options Menu while in Oscilloscope Mode. After measurement is stopped, the user can change the displayed parameters or adjust the x and y scales without losing the measured data.

The top section of the rightmost column summarizes the data set size and trigger setup parameters. The "Numbers" box specifies the number of points collected per data set. A data set is defined as the amount of data displayed on-screen by the scope traces, as well as the amount of data collected per trigger event in triggered operation. The number of points collected can be up to 80,000 points for free run or up to 30,000 points for triggered operation. The rest of the trigger parameters are described in the "Option Menu" section, as the trigger setup window can be accessed both from the "Trigger Settings" button on-screen and from the Options Menu while in Oscilloscope Mode.

The middle section of the rightmost column specifies the SOP reference Stokes parameters (s_1^{ref} , s_2^{ref} , s_3^{ref}) used to compute dREF. The default SOP reference point is (1, 0, 0).

The "Start" and "Stop" buttons have the same functions as in Sphere mode. The "Save" button allows the user to save measured data to a file, and the "Load" button loads previously saved data for display. A saved data file includes index number and Stokes parameters (S_0 , s_1 , s_2 , s_3) for each point.

When the measurement is stopped, a dynamic pointer indicator can be used to find measurement parameters for a particular point on the oscilloscope traces. Move the mouse pointer over a scope trace. An indicator box will display the x position of the pointer and the y-coordinate of the measured point at that x-coordinate.

Option Menu

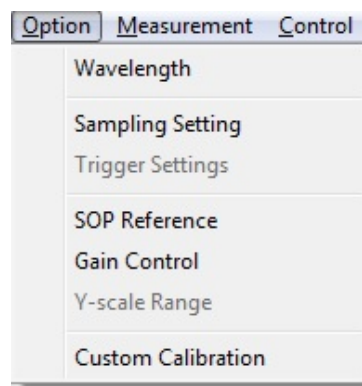

The Option menu allows the user to set the operation parameters for SOP measurement.

Wavelength

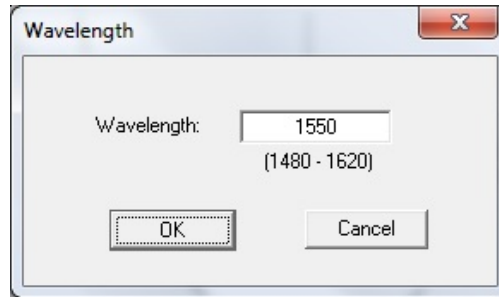

The wavelength setting determines the calibration matrix used for SOP measurement.

Wavelength range: 1480-1620nm or 1280-1340nm. PolaView auto-senses the wavelength range of the instrument to which it is connected.

Built-in calibration matrix wavelength spacing is 5nm for 1550nm instruments and 2nm for 1310nm instruments. The wavelength setting will round to the nearest multiple of 5 or 2, respectively.

Sampling Setting

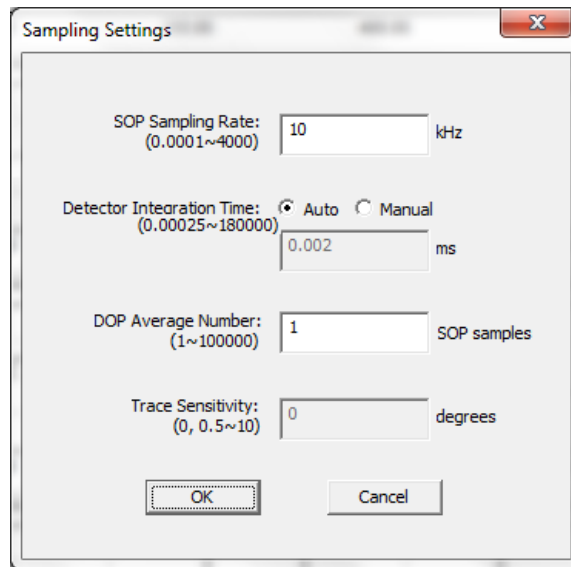

The Sampling Setting window allows the user to set several parameters that govern data collection and averaging.

SOP Sampling Rate:

The SOP sampling rate is the rate at which the instrument measures the SOP of the input light.

SOP Sampling Rate Range: 0.1 Hz to 4 MHz.

Default: 10 kHz.

PSY-201 User Guide

Note that the sampling rate is not necessarily the same as the data capture rate. The data capture rate is the rate at which SOPs are written to a file or displayed on-screen. Since, under some circumstances, not every sampled point is recorded,

$$\text{Data capture rate} \leq \text{SOP sampling rate.}$$

In sphere mode, the data capture rate is dynamic. It can vary between the base rate of 100 points/s and the SOP sampling rate, depending on the SOP variation rate and the trace sensitivity setting.

In oscilloscope mode, the data capture rate is equal to the SOP sampling rate.

Detector Integration Time:

The integration time can be set for either automatic or manual control. In automatic control, the integration time is dynamic, with its value determined by the gain, which can change with input power level.

Gain	3dB bandwidth	Average samples	Integration time
0-5	1MHz	4	1 μ s
6,7,8	600kHz	8	2 μ s
9,10,11	100kHz	40	10 μ s
12-18	10kHz	400	100 μ s

In manual control mode, the user can set a fixed integration time between 0.25 μ s and 180 s. The minimum integration time is 0.25 μ s, which corresponds to the highest sampling bandwidth of the instrument (4M SOP samples/second). If manual control is used, the value should be chosen such that

$$\text{integration time} \leq 1 / \text{sampling rate}$$

DOP Average Number:

The number of SOP samples averaged to calculate the DOP. This setting can be used to characterize polarization scrambler performance, for example.

Trace Sensitivity (Sphere mode only):

The SOP change threshold level that triggers capture of a new data point for the sphere display or "stream to file" functions. Effectively, it is the minimum resolution for the recorded data.

In sphere mode, the data capture rate is dynamic; it depends on both the trace sensitivity setting and the rate of change of the input SOP. The baseline data capture rate is 100 points/s. If ϵ is the trace sensitivity, as long as the input SOP does not change at a rate faster than 100 ϵ /s, data is captured at the baseline rate. As the rate of change of input SOP increases, the data capture rate varies dynamically such that there is a separation of no more than ϵ between consecutive collected SOPs, up to an upper limit of the SOP sampling rate setting (see Figure 33).

Trace Sensitivity range: 0, 0.5 to 10 degrees.

Trace Sensitivity = 0: Variable capture rate is disabled, and data capture rate = SOP sampling rate.

Trace Sensitivity ≥ 0.5 : Data capture rate increases with input Δ SOP rate, and is limited by the SOP sampling rate.

By adjusting the trace sensitivity, the user can set the SOP sampling rate at a very high speed in order to capture intermittent fast SOP changes, without collecting excessive amounts of redundant data while SOP movement is slow.

The sampling rate and trace sensitivity settings should be chosen to avoid data loss and maintain trace continuity (i.e. no gaps larger than the trace sensitivity in the SOP trace). To avoid data loss, trace sensitivity = 0 should only be used with sampling rate settings ≤ 500 K points/s.

In general, the sampling rate and trace sensitivity should be selected to match the expected rate of SOP variation. The sampling rate should be fast enough to accurately characterize the SOP variation, and the trace sensitivity should be large enough to avoid data loss. Figure 34 shows the continuity region of the SOP capture rate vs. average SOP change rate plot. The trace sensitivity should be selected to stay in the shaded area of the plot.

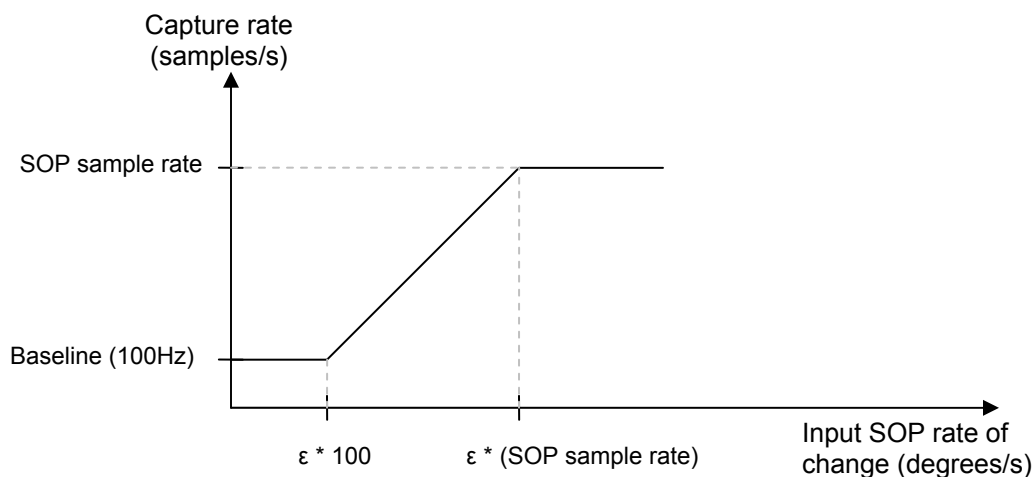

Figure 33 Plot showing relationship between SOP capture rate and input SOP rate of change, where ϵ is the trace sensitivity.

Example (dynamic data capture rate):

Trace Sensitivity setting = 5 degrees

SOP sampling rate setting = 1000kHz.

PSY-201 User Guide

For the settings in this example, the data capture rate and dSOP (angle difference between consecutive captured SOPs) varies as follows:

$\frac{\Delta SOP}{\Delta t}$ = Change in input SOP (kdegrees/s)	C = capture rate (kpoints/s)	dSOP (degrees)
≤ 0.5	=0.1	<5
$0.5 < \frac{\Delta SOP}{\Delta t} < 5000$	$0.1 < C < 1000$	=5
≥ 5000	=1000	>5

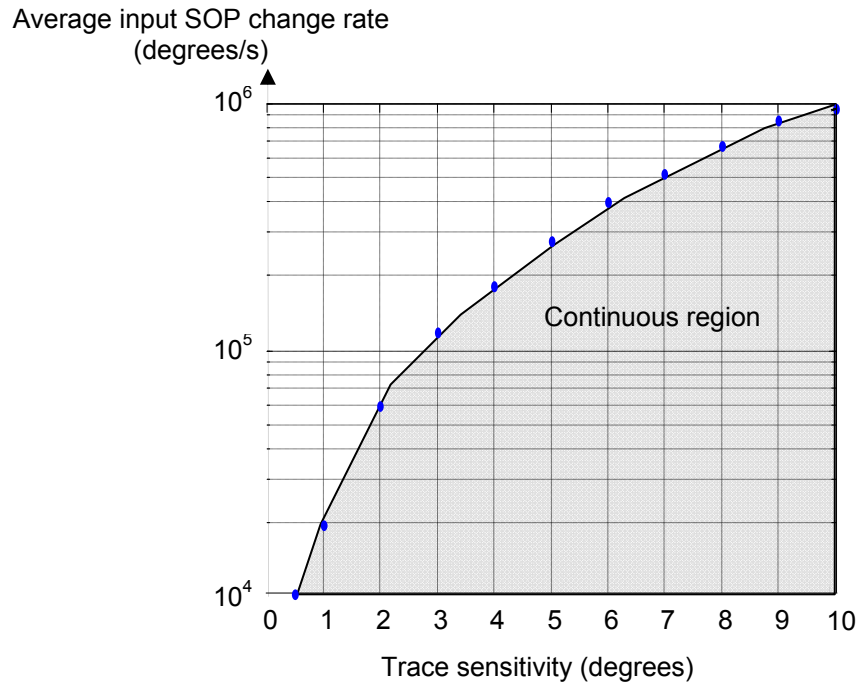
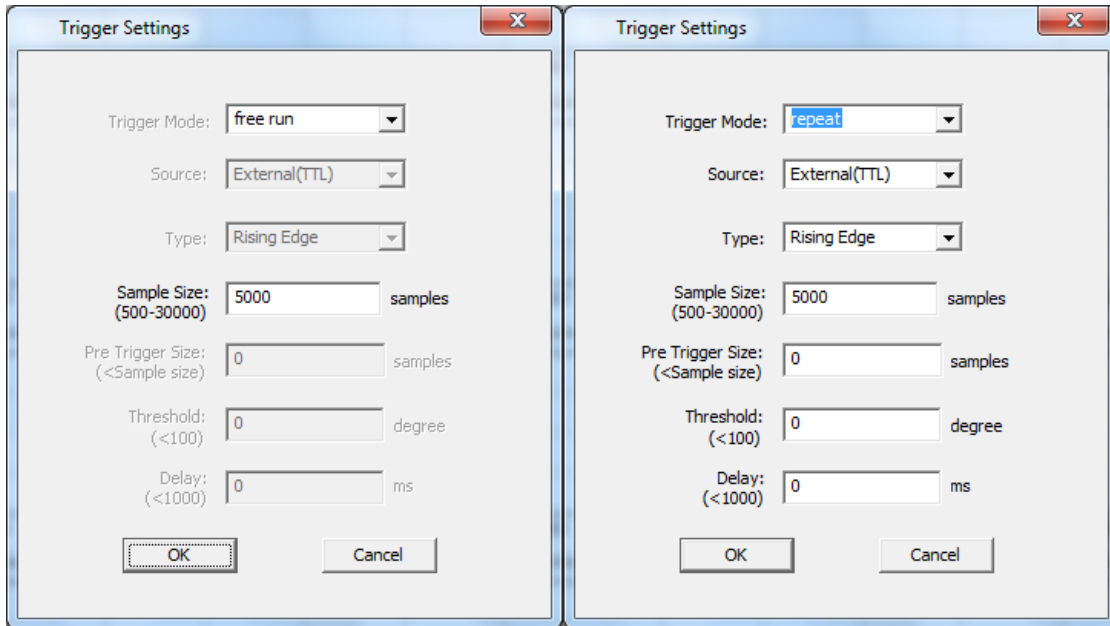

Figure 34 Average input SOP rate of change vs. appropriate trace sensitivity setting. Select trace sensitivity settings in the shaded area to avoid data loss.

Trigger Settings (Oscilloscope Mode only)



The Trigger Settings window allows the user to set up parameters for triggered measurement in oscilloscope mode.

Trigger Mode options: free run, repeat, single shot.

Free Run: Continuous data collection; no triggered operation. In this mode, the oscilloscope display refreshes at a rate of 30 frames/s.

Repeat: For edge triggers, one set of data collected per trigger event.

Single Shot: For edge triggers, one set of data collected when first trigger event occurs. No data collected for subsequent triggers.

Source: For mode = repeat or single shot, source options are external (TTL), dREF, and dSOP.

External (TTL): Trigger signal input to BNC connector on rear panel

dREF: Measurement trigger depends on a threshold SOP deviation from the reference value.

dSOP: Measurement is triggered when SOP deviation between two consecutive points exceeds the threshold level.

PSY-201 User Guide

Type: Defines what constitutes a trigger event for each source.

For source = external TTL, type options include rising edge, falling edge, and rising and falling edge.

For source = dREF, type options include rising edge, falling edge, rising and falling edge, above threshold or below threshold.

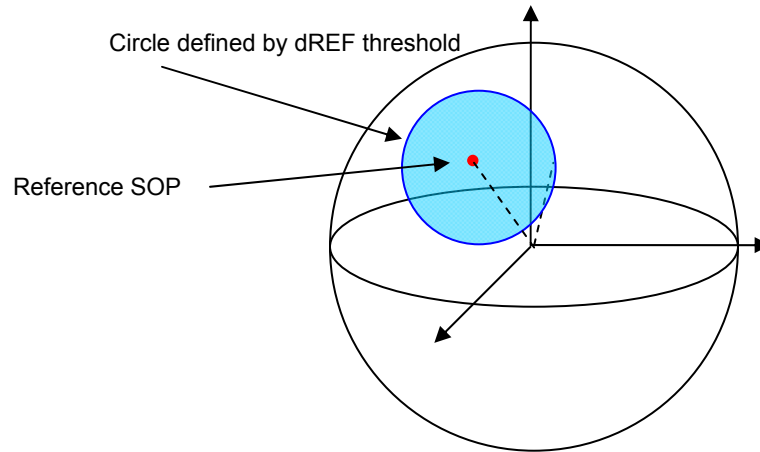

Figure 35 dREF trigger illustration

Figure 35 illustrates how the various trigger types relate to dREF. The point marked in red is the reference SOP. The dREF threshold defines a circle around the reference point (shaded in light blue, in the figure).

Above threshold: Measurement is triggered when the value of dREF exceeds the threshold level, and continues until it falls below the threshold level. In other words, data is recorded as long as the SOP is in the unshaded area.

Below threshold: Measurement is triggered when the value of dREF falls below the threshold level, and continues until it exceeds the threshold level. In other words, data is recorded as long as the SOP remains in the blue-shaded area.

Rising edge: One set of data is collected when the value of dREF goes from below threshold to above threshold (crossing from the blue area to the clear area in the diagram).

Falling edge: One set of data is collected when the value of dREF goes from above threshold to below threshold (crossing from the clear area to the blue area in the diagram).

For source = dSOP, the only available type option is rising edge: data is collected if the angle between any two consecutive points exceeds the threshold.

PSY-201 User Guide

Pre-Trigger Size: The number of points immediately preceding the trigger event to be included in the data set.

Sample Size: For edge triggers, the total number of points collected per data set. (up to 30,000 points)

Threshold: The dREF or dSOP value (in degrees) that triggers measurement when crossed.

Delay: The time offset between the trigger event and the beginning of data collection.

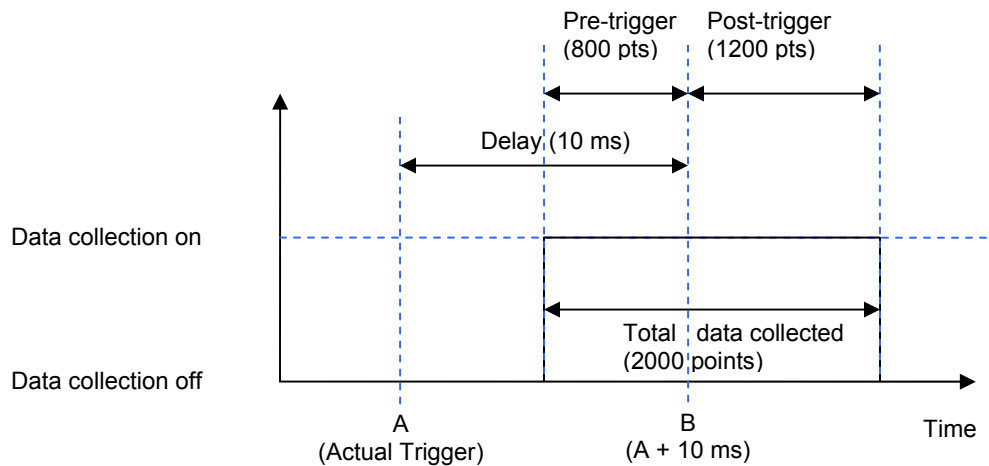

Figure 36 Triggered measurement timing diagram with example values.

Figure 36 shows the timing for an edge-triggered event. In this example, the sample size is set at 2000 points, and the pre-trigger size is set at 800 points. Therefore, 2000 total points should be collected, 800 immediately before the trigger event, and 1200 after the trigger event. The actual trigger event occurs at time A. However, because the delay is set to 10ms, PolaView treats time $B = A + \text{delay}$ as the trigger event. Therefore, 800 points are collected immediately before time B, and 1200 points after time B.

The pre-trigger feature is useful to observe the effect of some perturbation on the SOP. If the trigger is sent when the system is perturbed, the data set will include SOP information both before and after the perturbation occurs.

The delay feature is useful in cases where the POD-201 or PSY-201 is used to observe the SOP at the end of a system with a long optical path. For example, if light takes 10ms to travel from the system input to the observation point, then if a pulse is launched into the system at time A, with a synchronized trigger pulse sent to the instrument at time A, then the instrument will collect data at time $B = A + 10\text{ms}$, when the pulse arrives at the observation point.

SOP Reference

The SOP Reference window allows the user to set the reference point that defines dREF. Reference options include the 6 Poincaré sphere pole points (H, V, +45, -45, RHC, LHC), the current measured SOP, the current reference saved by the POD-201 or PSY-201, and an option for manual entry.

PSY-201 User Guide

For the preset SOPs (pole points), the SOP selection determines the Stokes parameters, the power reference is set at 1mW, and the DOP reference is set at 100%.

For "current SOP", the current measured Stokes parameters, power level, and DOP are set as the reference.

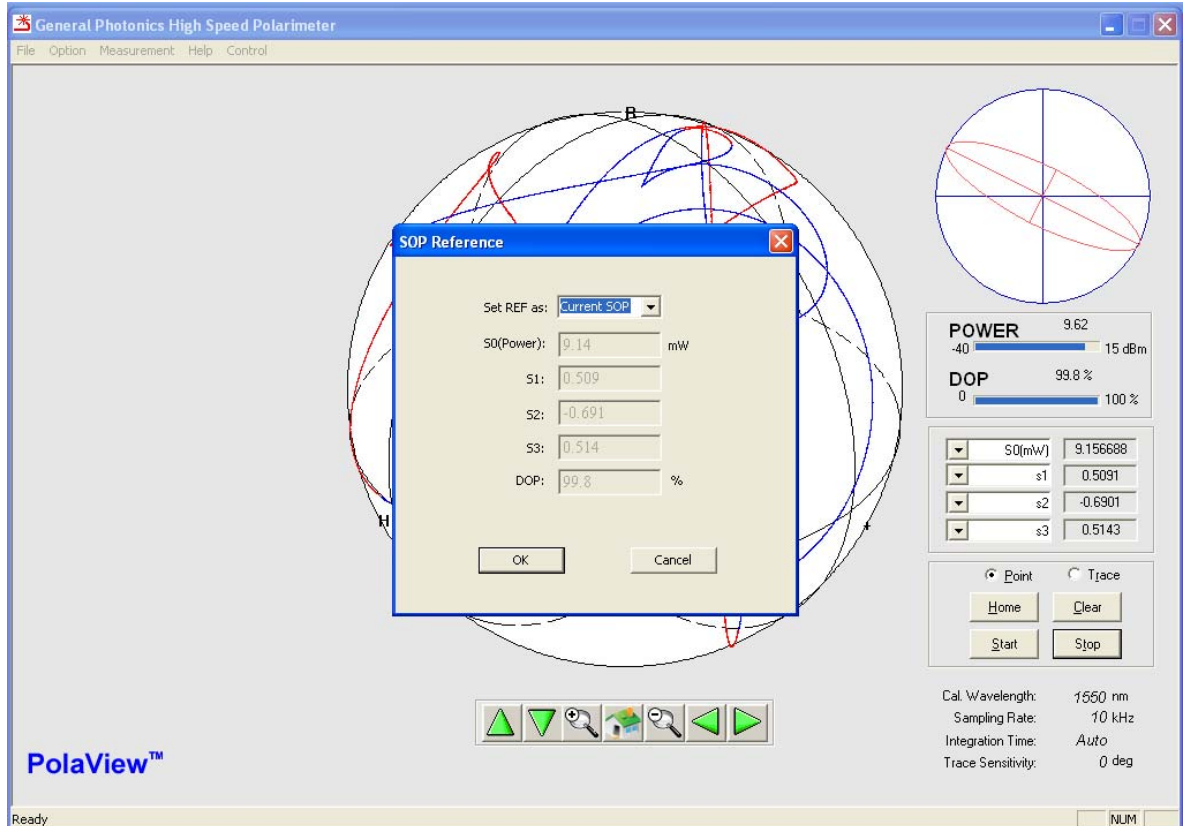

For "current REF", the reference Stokes parameters, power level, and DOP stored in the instrument are used. This is the default setting.

For manual entry, the user can manually set all of the reference parameters, as shown below.

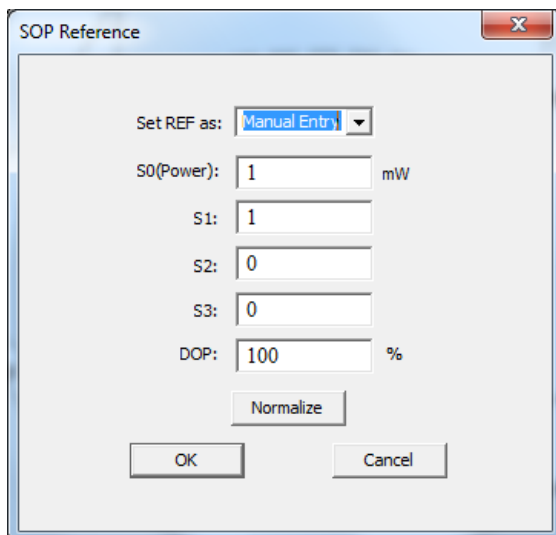

PSY-201 User Guide

The S-parameters initially entered do not have to be normalized. Clicking the “Normalize” button normalizes the Stokes parameters to the surface of the Poincaré sphere.

Gain Control

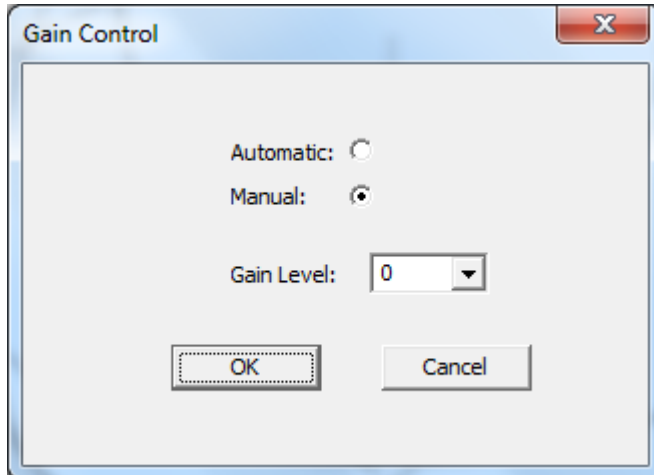

The gain control window allows the user to set the gain control mode to automatic (gain level may vary with power level) or to manually set a fixed gain level (0 to 18).

Y-Scale Range

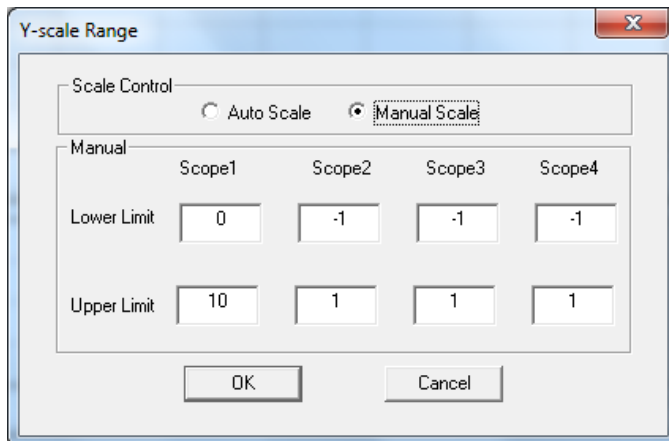

In Oscilloscope mode, PolaView has 4 scope windows. The Y-Scale Range setup allows the user to configure the Y axis for the scope traces.

The Y scale control options are:

1. **Auto Scale:** The Y-scale range depends on measured values. When a value exceeds the current Y-scale range limit, the Y-scale range automatically rescales to accommodate new values.
2. **Manual Scale:** The user sets fixed ranges for each of the 4 oscilloscope graphs. Note that data values may exceed the range limits.

Custom Calibration

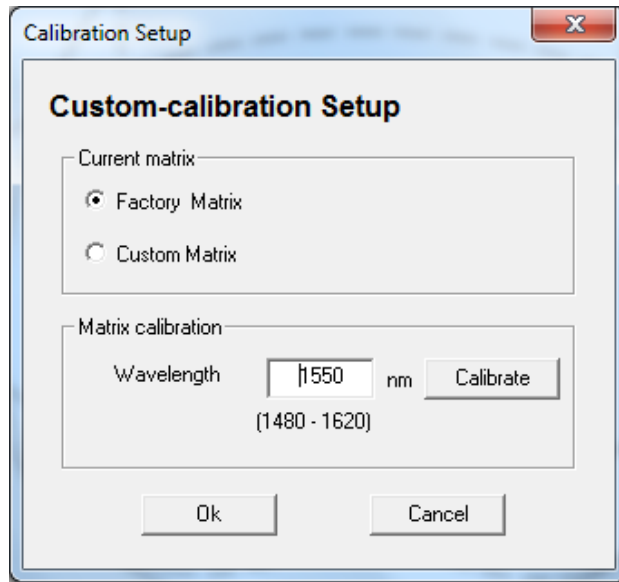

The calibration setup window allows the user to select the polarimeter calibration matrix to be used for SOP measurement.

Factory Matrix: The POD-201 or PSY-201 comes with a set of factory-generated calibration matrices for wavelengths in its operating wavelength range. If "Factory Matrix" is selected, then the wavelength setting determines the built-in calibration matrix that is used for measurement. Factory matrices are spaced at 5 nm intervals for 1550nm instruments and at 2nm intervals for 1310nm instruments.

Custom Matrix: If this option is selected, the user can load a user-generated calibration matrix to use for measurement.

Matrix Calibration: Use this function to generate a new calibration matrix for the current operating conditions (wavelength, temperature). Such a calibration matrix can yield more precise results under particular operating conditions, or can be used to generate calibration matrices for wavelengths outside of the instrument's nominal operating range, although the measurement performance may not be as good as for wavelengths in the range.

To generate a new matrix, type the light source wavelength into the "Wavelength" box, and click "Calibrate".

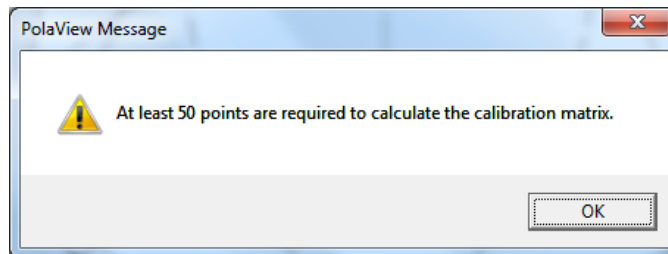

PSY-201 User Guide

Creation of a new calibration matrix requires measurement of at least 50 different SOPs. Click "OK" on the notification window button.

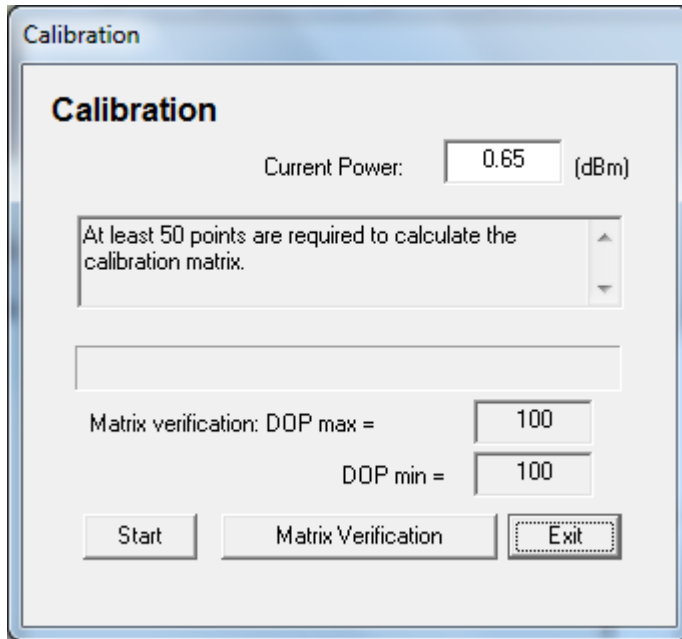

Click "Start" to begin matrix generation. PolaView uses the PSY-201's triangle scrambling function at a scrambling rate of $3 \times 2\pi/s$ to create the required set of diverse SOPs.

The points will be marked on the sphere as they are recorded, and the status window will notify the user when the requisite number of points has been recorded.

PSY-201 User Guide

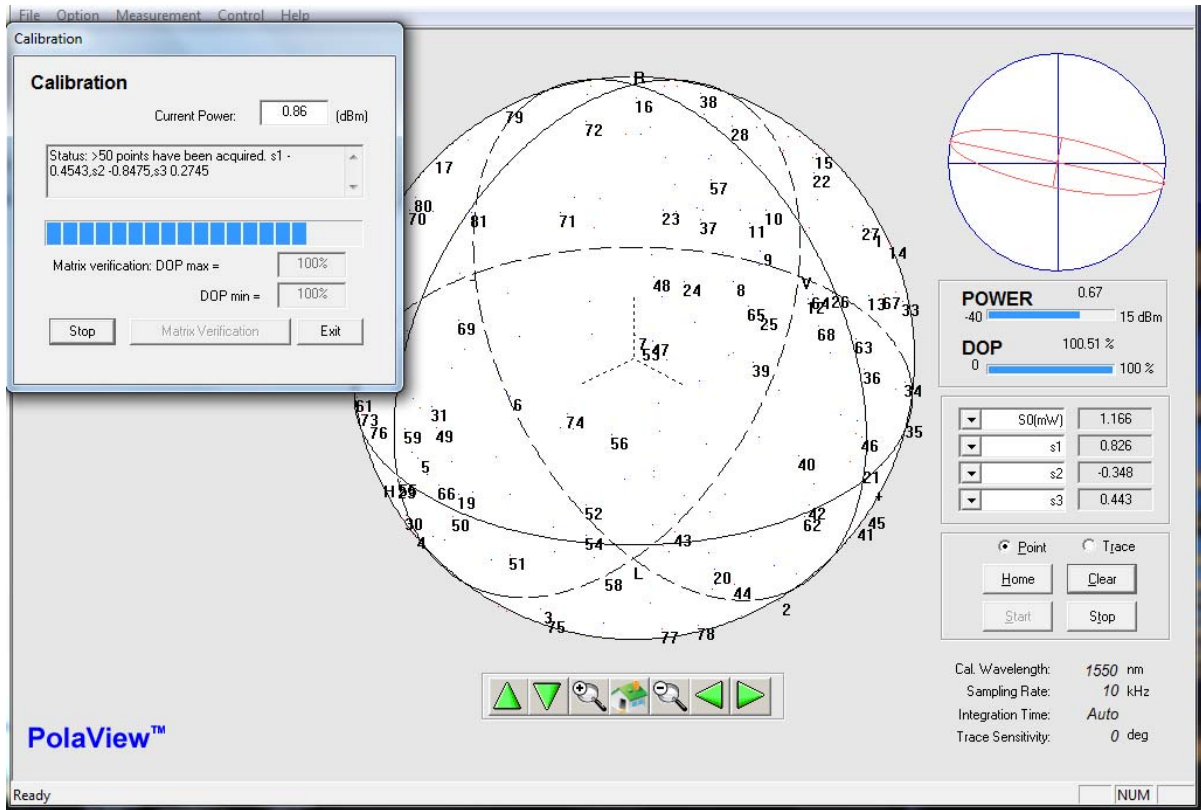

Once the measurement is completed and the matrix is generated, the user will be prompted to name and save the matrix file. The file will have file extension .DAT but can be opened as a text file for viewing.

To check the new matrix before using it, click "Matrix Verification". Polaview will run through a verification process and then indicate whether the verification was successful or not.

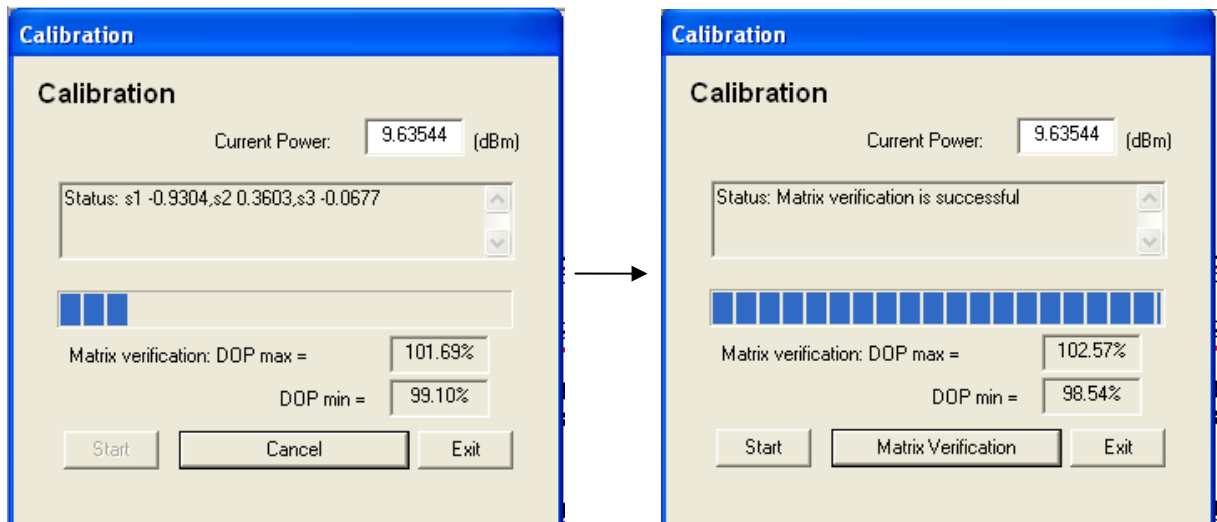

Once a new matrix is created and saved, it can be loaded by selecting "Custom Matrix" from the main Calibration Setup window and selecting the new file to be loaded.

Measurement Menu

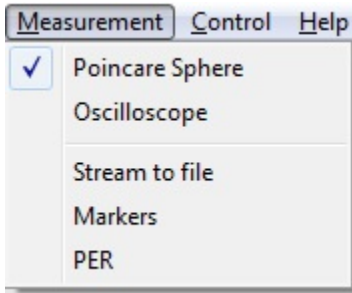

The Measurement Menu lists available measurement options.

Poincaré Sphere

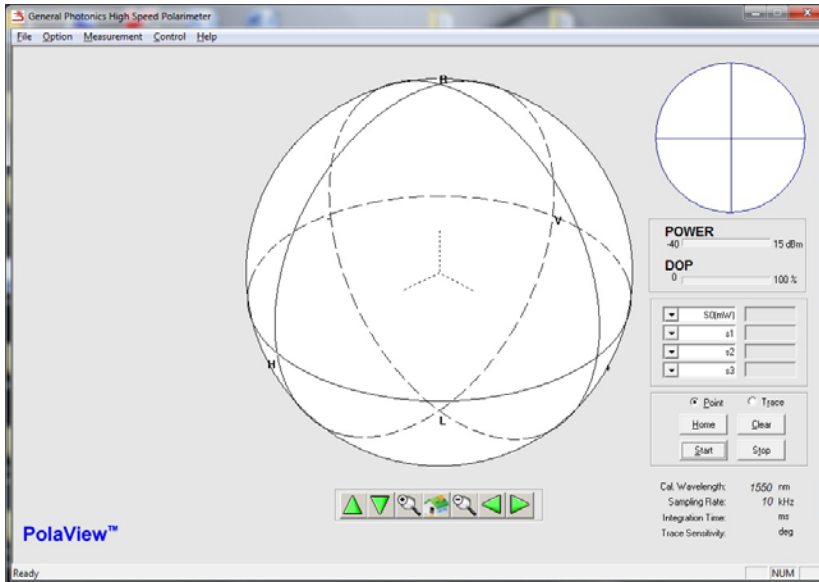

This option displays data on a Poincaré Sphere. It is the default data display mode.

Oscilloscope

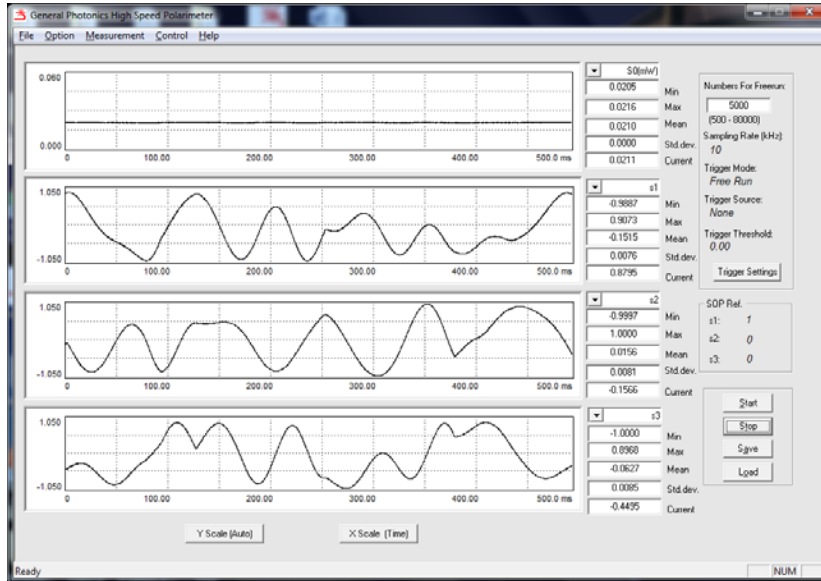

This option displays data on a virtual oscilloscope window and allows for triggered measurement.

Stream to File

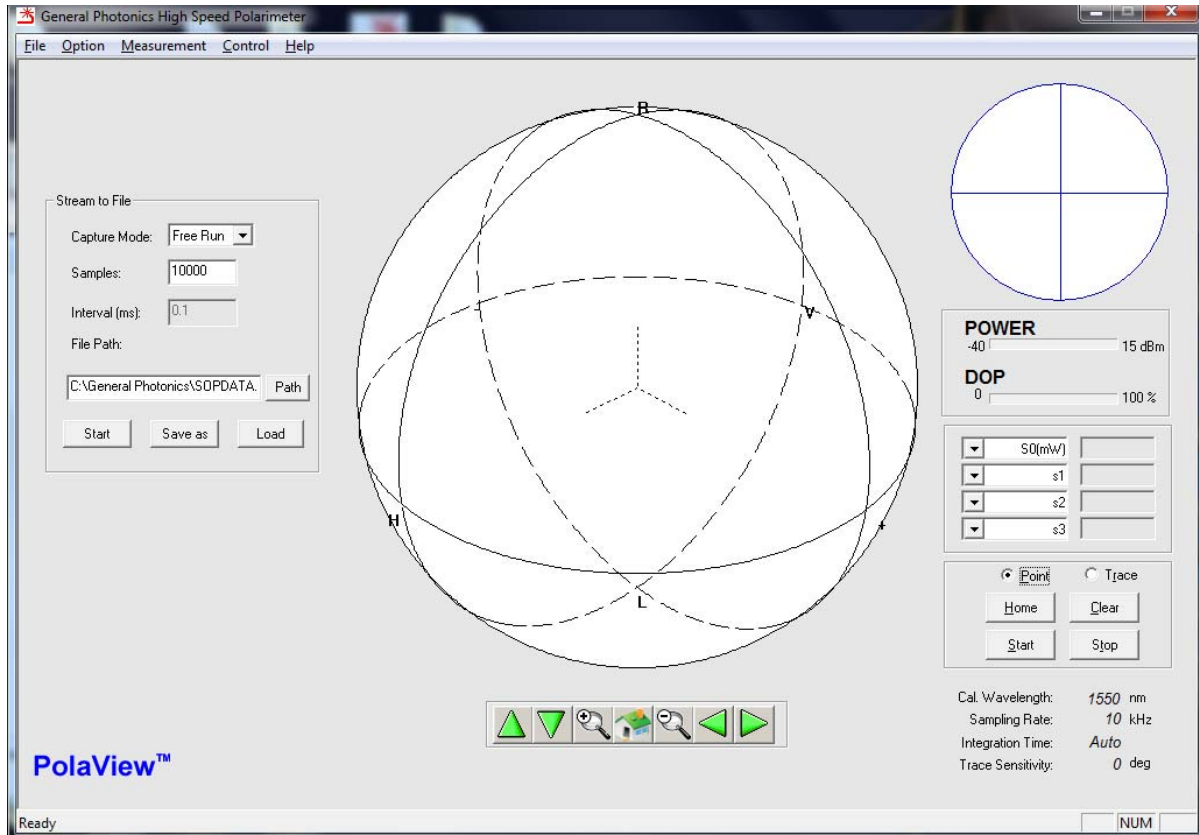

The “stream to file” function saves measured data to one or more text files, as well as displaying it on the sphere. Selecting this option from the Measurement menu causes the “stream to file” control pane to appear on the left side of the screen.

Saved data for each point includes the time stamp (in ms), Stokes parameters, instantaneous DOP, and average DOP. Average DOP uses the “DOP Average Number” of SOPs to calculate the DOP. “DOP Average Number” can be set from “Sampling Settings” on the Options menu.

Capture Mode

Free Run: Points are recorded at a rate determined by the sampling rate and trace sensitivity settings. Because the “Stream to File” function works in Sphere mode, it uses the same dynamic data capture rate. While the polarization is stable, the default rate of 100 points/s is used. For fast polarization variations, the data capture rate can increase up to the sampling rate setting.

Timed: Points are recorded at intervals specified by the user in the “Interval” box.

Samples: The total number of points to be collected. Up to 1,000,000,000 total points can be collected. Up to 50,000 points can be stored in one file. If the total number of points is >50,000, the data will be stored to multiple files.

PSY-201 User Guide

Interval: The interval between recorded points, in Timed mode, in ms.

Range: 0 to 50,000 ms.

File Path: Specify the file path for the data to be saved. Data will be streamed to that location as it is collected.

Start: Start measurement.

Save as: Measured data can be saved to another location or filename after data collection is finished.

Load: Load previously saved data for display on the sphere. Multiple data files can be overlaid on the sphere display. This function displays all measured points in a file. It is separate from the Replay function.

Replay Stored Data Files

Data files saved from the Stream to File function can also be loaded for replay as a virtual movie to more clearly view the SOP evolution over time. The replay speed can be decreased to view fast phenomena at a visible speed or increased for a time-lapse view of slow polarization evolution.

To use this function, instead of using the Load button in the Stream to File control pane, select Replay from the File menu.

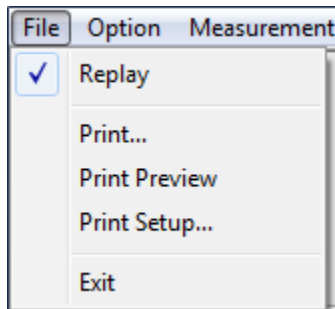

A file selection window will appear.

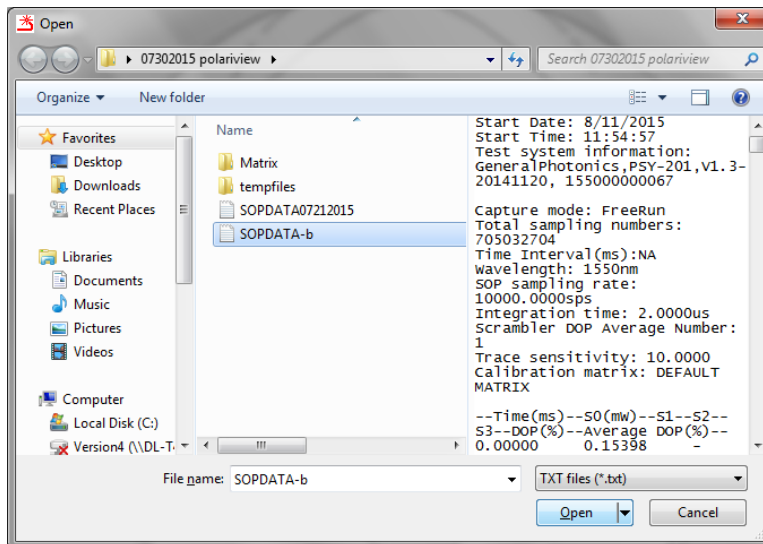

PSY-201 User Guide

Select the desired data file and click "Open".

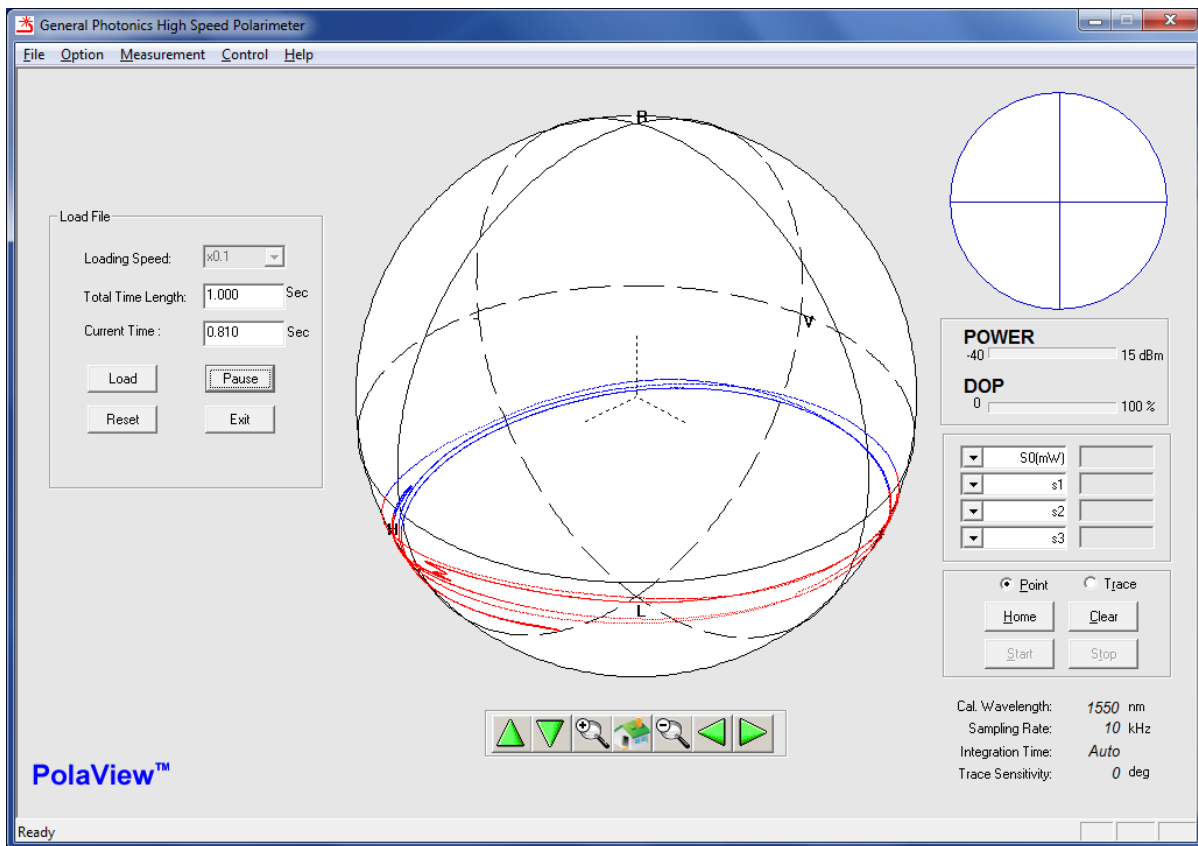

The Replay control pane will appear on the left side of the screen.

Loading Speed: Select the relative speed for playback.

	<p>x0.01 slow down by a factor of 100</p> <p>x0.1 slow down by a factor of 10</p> <p>x1 real-time playback</p> <p>x10 speed up by a factor of 10</p> <p>x100 speed up by a factor of 100</p>
--	--

Total Time Length: Duration of the recorded data sequence in the selected file, in seconds.

Current Time: Counter showing the time stamp of the data during playback.

Load: Load a new file for replay. If the sphere is not cleared before loading the new file, the data from the new file will be overlaid over the data from the previous replayed file.

Play/Pause: Clicking "Play" begins the playback. During playback, this button can be used to pause and resume play.

Reset: Resets the counter to 0. Clicking "Play" after "Reset" starts the replay from the beginning of the file.

Exit: Exits the function and removes the "Replay" control pane from the screen.

PSY-201 User Guide

Note that the “total time length” and “current time” boxes use the actual time stamps for recorded data. Therefore, the speed setting only affects the update speed of the counter.

Markers

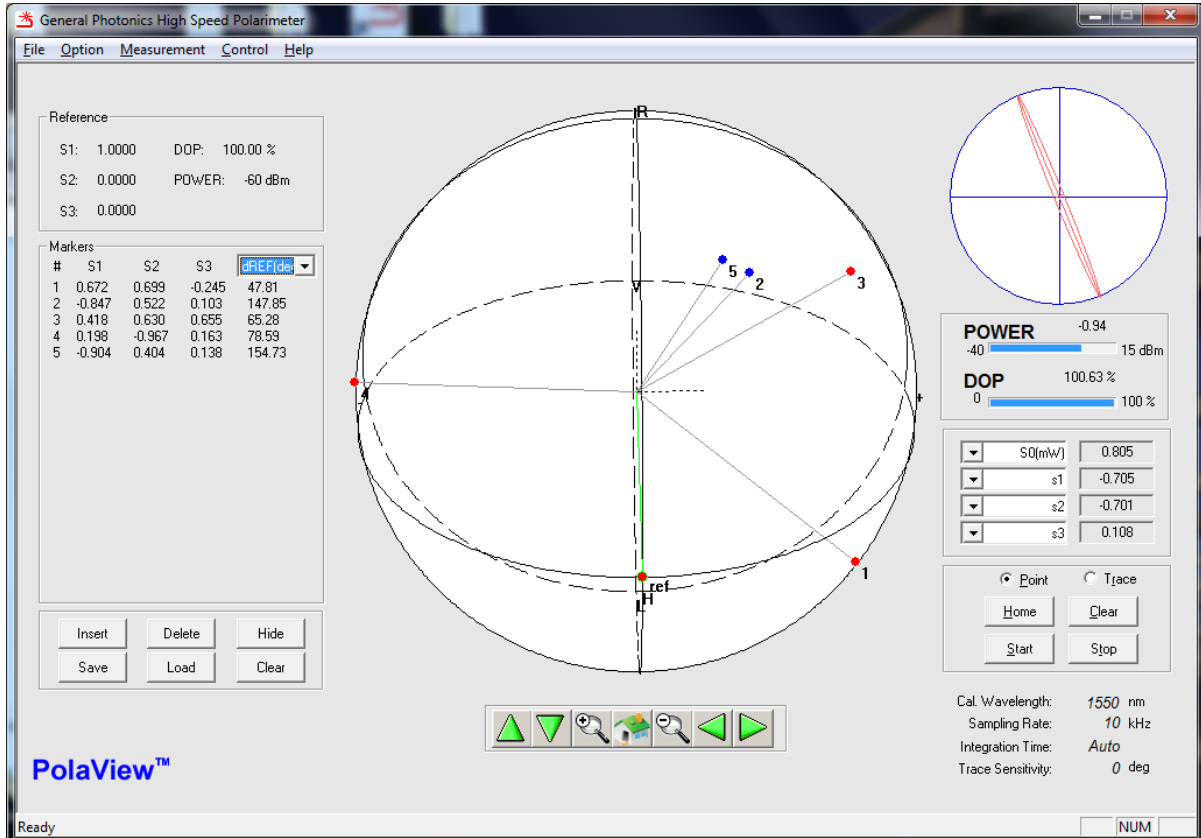

This option allows the user to mark points on the sphere and measure the angles between marked points or between marked points and a reference SOP. Up to 99 points can be marked. Selecting the Marker option from the Measurement menu causes the Marker control pane to appear on the left side of the screen.

Reference: The top section lists the current reference SOP. This can be changed by selecting Reference SOP from the Options menu.

Markers: The middle section lists the Stokes parameters of all marked points. The 4th parameter position can be configured to display S0, DOP (%), Azimuth, Ellipticity, DLP, DCP, dSOP (SOP difference between consecutive markers, in degrees), dDOP (DOP difference between consecutive markers, in %), dPower (power difference between consecutive markers, in dB), dREF (SOP difference between marker and reference SOP, in degrees), dREF dop (DOP difference between marker and reference), or dREF pow (power difference between marker and reference). If dREF or dSOP are selected, PolaView will display vector lines from the origin to the markers for visual clarity of the angles. If dREF is selected, the reference SOP will also be shown as a green marker, with a vector line to the origin.

PSY-201 User Guide

Buttons:

Insert: Add a new marker at the currently measured SOP.

Delete: Delete selected or most recent marker.

Hide: Hide markers.

Save: Save marker information to a text file.

Load: Load a previously saved set of markers for display.

Clear: Clear all markers.

A saved marker file includes S_0 , s_1 , s_2 , s_3 , and DOP information for each marker.

Deselect Markers from the Measurement menu to remove the marker control pane.

PER

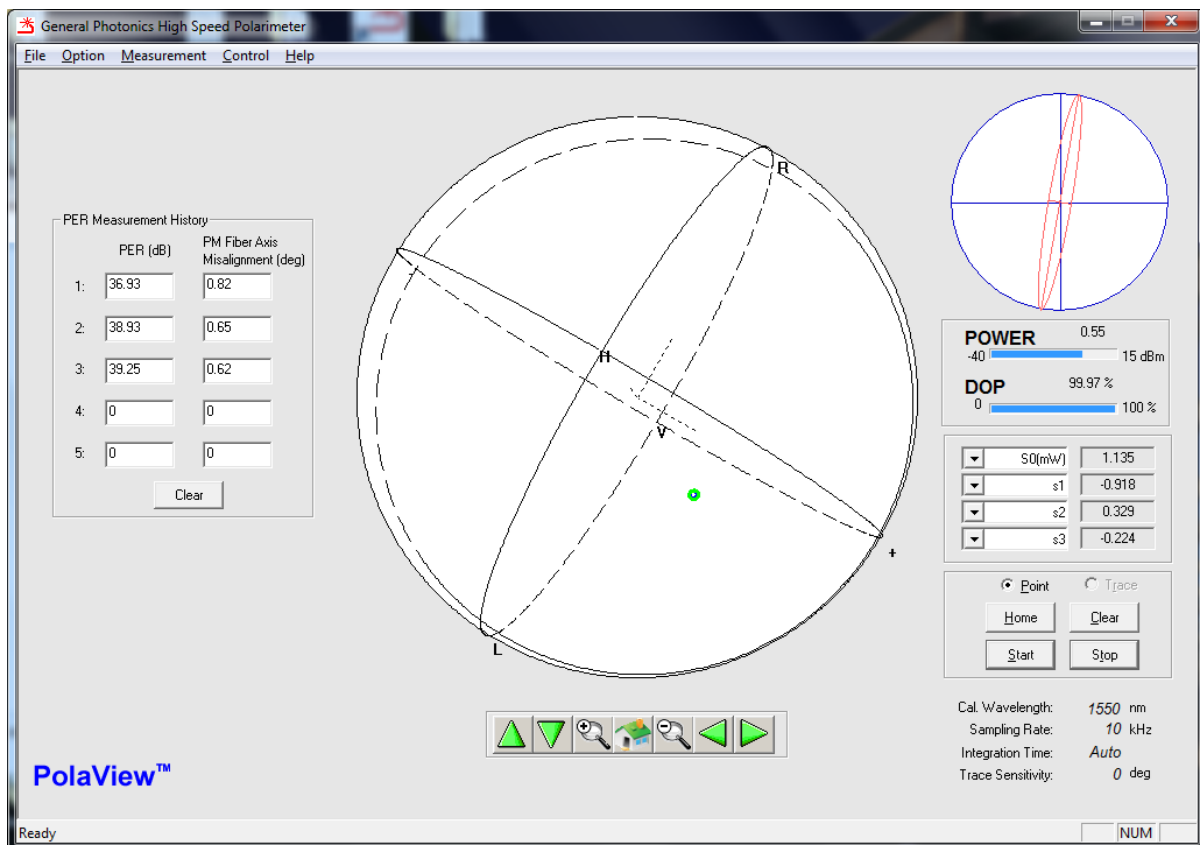

Selecting PER brings up the PER measurement pane.

PER Measurement Background:

To minimize polarization dependent effects, it is often desirable to maintain a constant state of polarization as light propagates through an optical system. With regard to such systems, polarization extinction ratio (PER), or polarization crosstalk, is a measure of the degree to which the light is confined in the principal polarization mode. It is defined as the ratio of the power in the principal polarization mode to the power in the orthogonal polarization mode after propagation

through the system, expressed in dB. The crosstalk measured at any point in the system is the result of the cumulative effects of the polarization properties of the light source (light not fully polarized or not linearly polarized), misalignments at fiber connections or splices, and propagation through the fiber itself up to the measurement point.

Polarization maintaining optical fibers have an optical (slow) axis defined by a strong linear birefringence. If light input to an ideal PM fiber is polarized along its optical axis, the polarization state will be maintained during propagation through the fiber. However, if it is misaligned, or is not fully polarized, the component polarized along the slow axis propagates at a different speed than the component polarized along the fast axis. Thus, the polarization state of the light changes with the relative phase delay between the two components as it propagates through the fiber.

For the case of a linearly polarized light beam launched into a PM fiber with its polarization axis rotated by an angle θ from the PM fiber's slow axis, as shown in Figure 37, the extinction ratio due to the misalignment can be calculated as

$$PER = -10 \log(\tan^2 \theta) \quad (1)$$

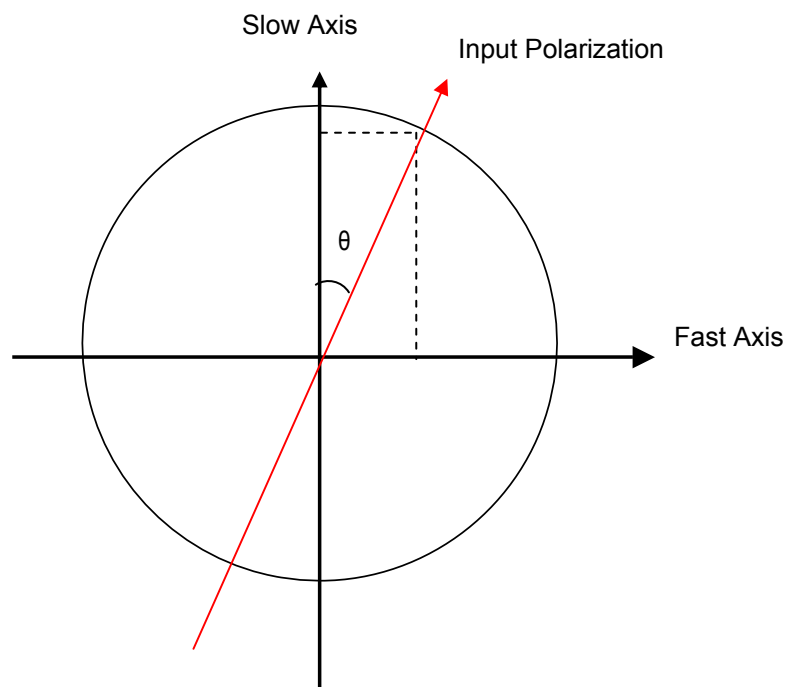

Figure 37 A representation of linearly polarized light misaligned by an angle θ from the slow axis of a PM fiber

The misalignment angle is difficult to measure directly, as it depends on the determination of the orientation of the fiber's slow axis.

Changes in the fiber length due to temperature changes or mechanical stress change the relative phase delay between the two orthogonal polarization components, causing the state of polarization of the output light to rotate along a circle on the Poincaré sphere. The rotation axis of

the circle is defined by the optical (slow) axis of the PM fiber, and the radius of the circle by the misalignment of the light to the slow axis, as shown in Figure 38.

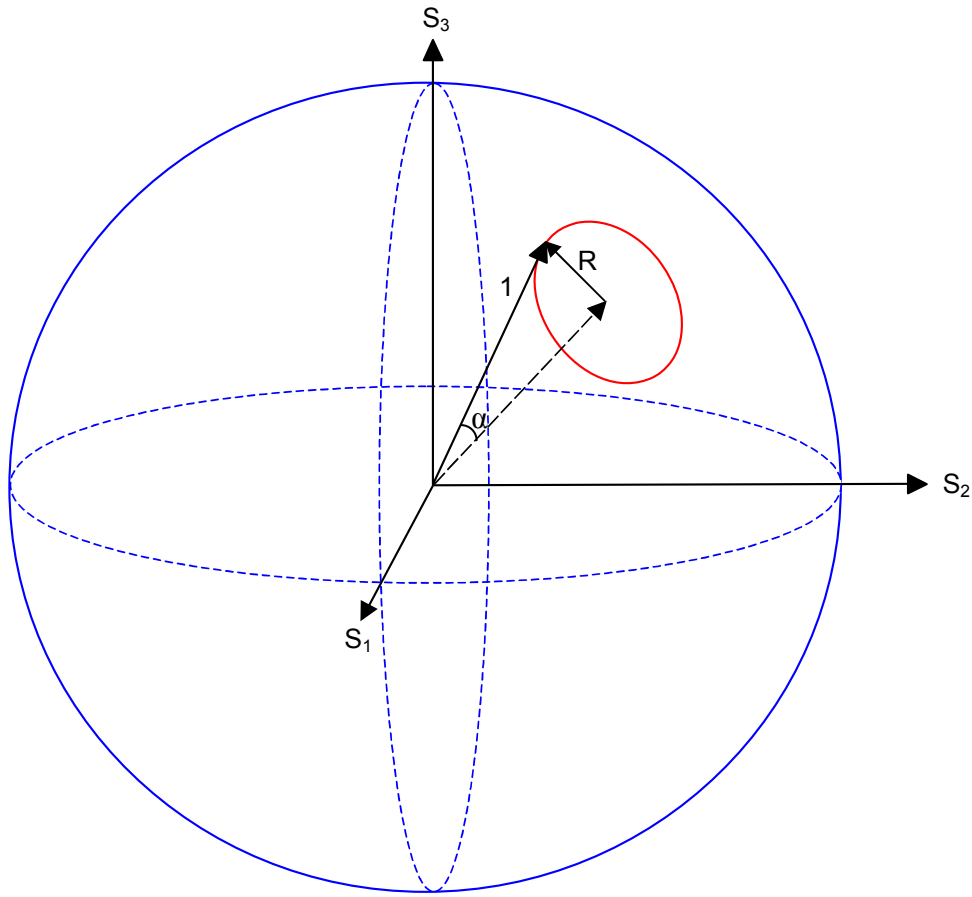

Figure 38 Poincaré Sphere illustration of polarization state rotation of output light from a PM fiber due to thermal or mechanical stress

The polarization extinction ratio, then, can be calculated directly from the size of the circle:

$$PER = -10 \log \left(\frac{\sin^2 \frac{\alpha}{2}}{\cos^2 \frac{\alpha}{2}} \right) = -10 \log \left(\frac{1 - \cos \alpha}{1 + \cos \alpha} \right) = -10 \log \left(\frac{1 - \sqrt{1 - R^2}}{1 + \sqrt{1 - R^2}} \right) \quad (2)$$

For complete confinement in one mode, $R \rightarrow 0$ (the circle collapses to a point), corresponding to $PER \rightarrow \infty$. At the other extreme, if the light is evenly distributed between the two orthogonal polarization modes, $R \rightarrow 1$ (the circle becomes a circumference of the sphere), corresponding to $PER \rightarrow 0$.

Since this is a relative measurement, dependent only on the size of the circle and not on its absolute position on the Poincaré sphere, the PM fiber under test does not need to be directly

PSY-201 User Guide

connected to the polarimeter. Intermediate sections of SM fiber will change the position of the circle, but not its size, as long as the fiber does not move during the measurement.

PER Measurement Using the POD-201 or PSY-201

1. Connect the system under test to the POD-201 or PSY-201. Make sure that all of the fiber sections except the section under test are immobilized.
2. If the system ends at the POD-201 or PSY-201 (i.e., no further components are connected to the output of the POD-201 or PSY-201), terminate the POD-201 or PSY-201 output to prevent backreflections. This can be done by connecting the output port to an isolator or absorber, or to a fiber jumper with an APC connector on the other end.
3. From the Poincaré sphere display mode, click "Stop" in the box at the bottom right corner of the screen to stop data acquisition. Make sure that "Point" rather than "Trace" is selected.
4. Select "PER Measurement" from the "Measurement" menu.
5. Click "Start" to start data acquisition for the PER measurement.
6. Slowly heat or stretch the section of PM fiber under test until the SOP traces out close to a full circle on the Poincaré sphere. If stretching the fiber, make sure that it does not bend, as this can cause mode coupling.
7. Once sufficient data points are present (close to a full circle), click "Stop" to stop data acquisition and begin the PER calculation. The software will perform a curve fitting to fit a circle (shown in green) to the measured data points, and then use the radius of the circle to calculate the PER. When it is finished, the results will appear in the "PER Measurement History" section of the display. The measurement history displays the 5 most recent PER measurements.
8. The "Clear" button can be used to clear measurement results.
9. When the PER measurement is finished, use the "Exit" button to exit PER measurement and remove the PER measurement pane from the display.

Control Menu

This menu includes the main polarization control functions for the PSY-201. If PolaView is used with a POD-201, the control menu will be inactive.

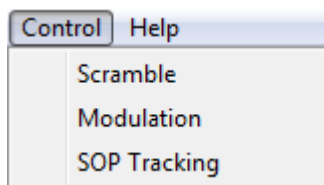

For all items on the control menu, selecting a function brings up the corresponding control pane on the left side of the screen. The right side of the screen shows the standard measurement control/display options.

The polarization control functions are decoupled from the measurement functions. To display the effect of a polarization control function using the Poincaré sphere, first enable that

PSY-201 User Guide

function in the control pane on the left, then click "Start" on the polarization measurement control section at the bottom left of the screen.

Scramble

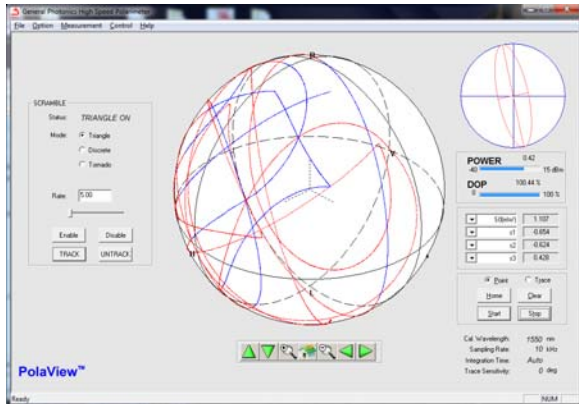

Triangle

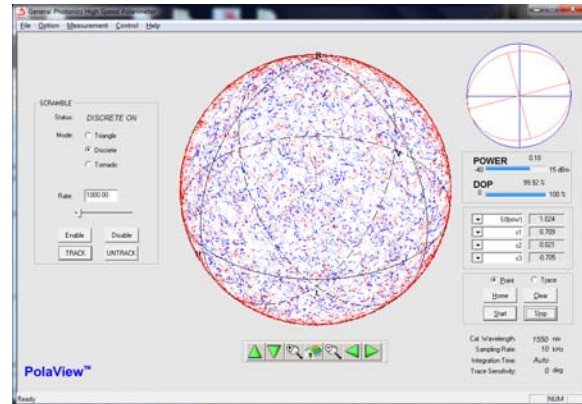

Discrete

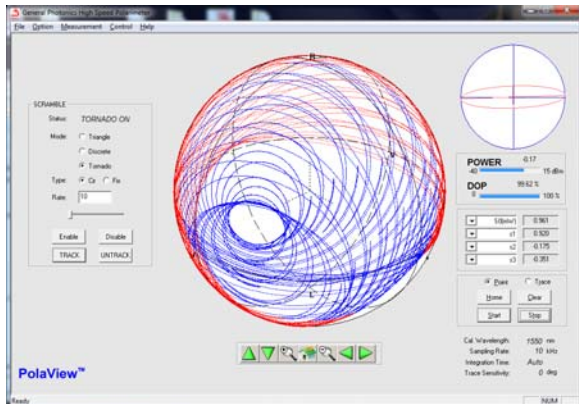

Tornado, rotating axis

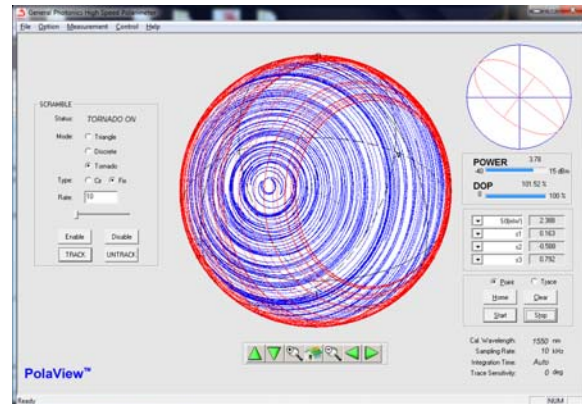

Tornado, fixed axis

The scrambling control pane allows the user to activate the PSY-201's triangle, discrete, or Tornado scrambling functions from within PolaView. Select the scrambling mode, scrambling rate, and for Tornado mode, axis rotation option, then click "Enable" to begin scrambling.

Scrambling modes: Triangle, Discrete, Tornado

Scrambling rates: Triangle: 0 to $2000 \times 2\pi/s$

Discrete: 0 to 20,000 points/s

Tornado: 0 to 2000 Rev/s

Axis rotation option (Tornado only): Cir = rotating axis, Fix = fixed axis

Enable: Begin scrambling using selected scrambling setup.

Disable: Stop scrambling; polarization controller remains in setting at which it was stopped, but output SOP is not actively stabilized.

Track: Stop scrambling and stabilize output SOP to current state.

Untrack: Disable stabilization.

PSY-201 User Guide

The "Track" button is the functional equivalent of the TRACK quick key on the PSY-201 front panel. However, in PolaView, "Untrack" only disables active tracking. It does not restart any polarization control functions interrupted by invoking the TRACK function.

Modulation

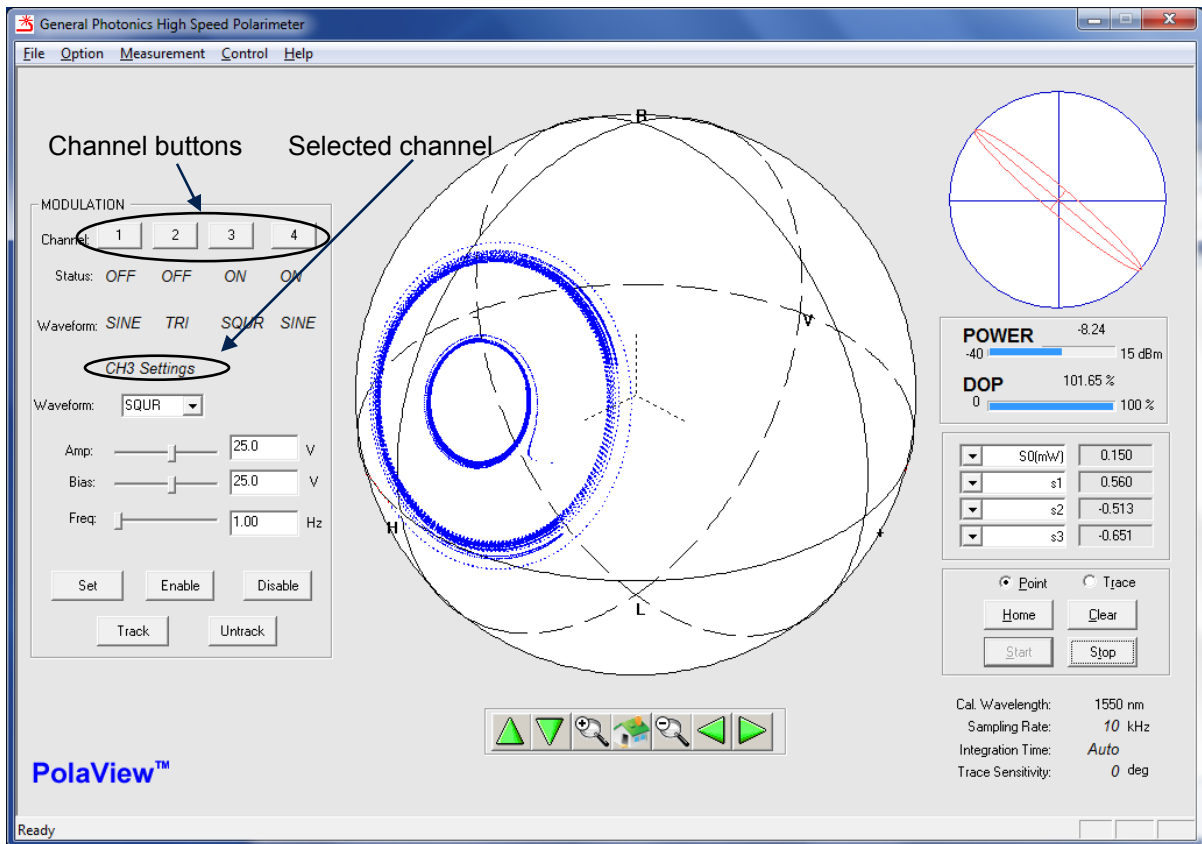

The modulation control pane allows the user to apply a periodic waveform control signal to each of the 4 fiber squeezers of the polarization controller.

The enable/disable status and waveform type for each channel is displayed in the status summary area immediately below the channel buttons. Clicking on a channel button selects that channel. The detailed settings for the selected channel are displayed in the waveform setup area on the bottom left of the screen.

Waveform setup:

Waveform type (pull-down menu):	Sine, square, triangle
Amplitude:	0 to 45V
Bias (Offset):	A to 45V, where A is the amplitude
Frequency:	0 to 1000 Hz

PSY-201 User Guide

- Set:** Apply setup options (waveform type, amp, bias, freq) to selected channel.
- Enable:** Enable waveform for selected channel.
- Disable:** Disable waveform for selected channel.
- Track:** Stop modulation and stabilize output SOP to current state.
- Untrack:** Disable stabilization.

Unlike the front panel control, the PolaView waveform control allows the waveforms for individual channels to be enabled/disabled independently.

The "Track" button is the functional equivalent of the TRACK quick key on the PSY-201 front panel. However, in PolaView, "Untrack" only disables active tracking. It does not restart any polarization control functions interrupted by invoking the TRACK function.

SOP Tracking

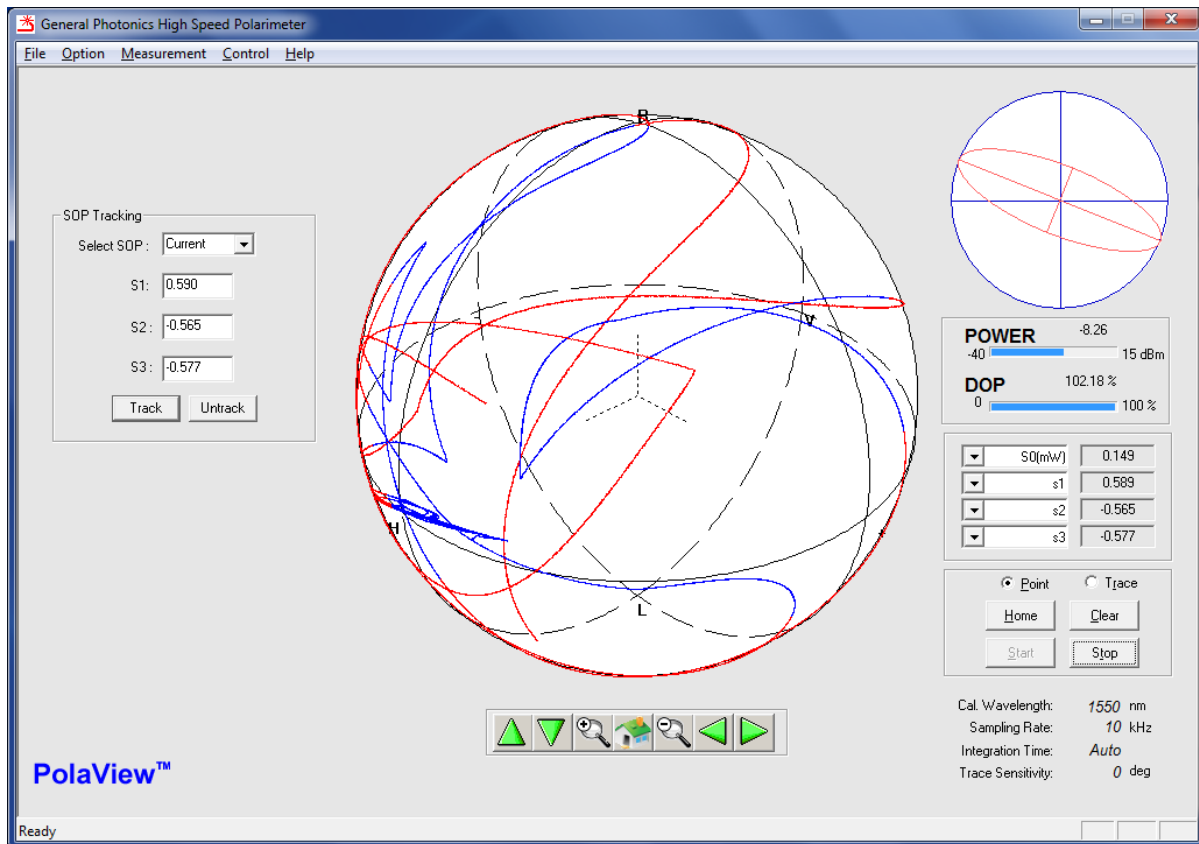

The SOP Tracking function maintains a designated output SOP against input SOP variations. Select the SOP to be maintained and click the "Track" button. To disable SOP stabilization, click the "Untrack" button.

PSY-201 User Guide

SOP options:

- Current: Maintain current measured SOP
- Manual: Designate an SOP by entering Stokes parameters. Stokes parameters are normalized to the surface of the sphere when the "Track" button is clicked.
- Basis SOPs: H, V, +45, -45, RHC, LHC

The "Track" button is the functional equivalent of the TRACK quick key on the PSY-201 front panel. However, in PolaView, "Untrack" only disables active tracking. It does not restart any polarization control functions interrupted by invoking the TRACK function.